

# Neria

## GARDEROBA

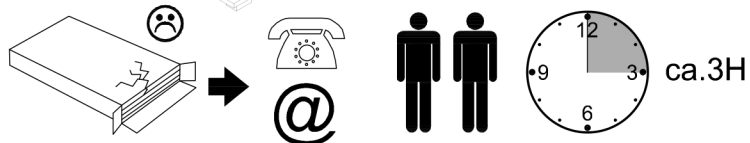
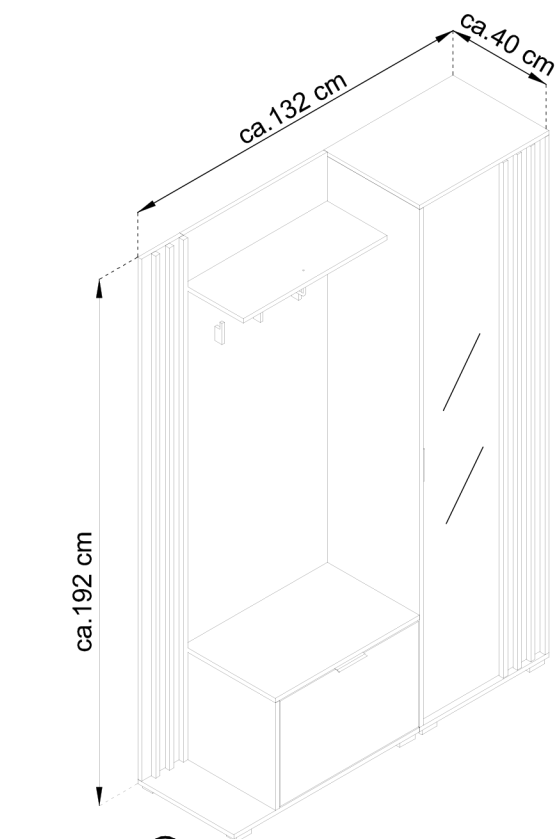
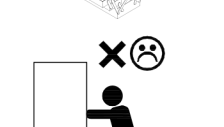
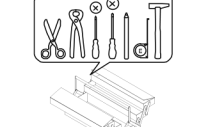
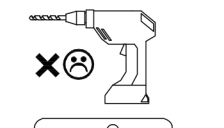
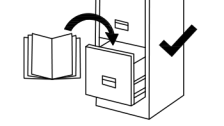
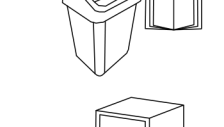
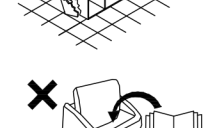
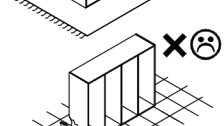
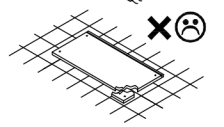
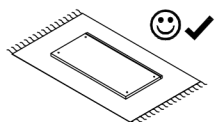

- (D) Montageanleitung
- (FR) Notice de montage
- (NL) Handleiding voor de montage
- (CZ) Montážní návod
- (HU) Szerelési útmutató
- (TR) Montaj talimatı

- (GB) Assembly Instructions
- (IT) Istruzioni di montaggio
- (PL) Instrukcja montażu
- (SK) Návod na montáž
- (RO) Instrucțiuni de montaj
- (RU) Инструкции по монтажу

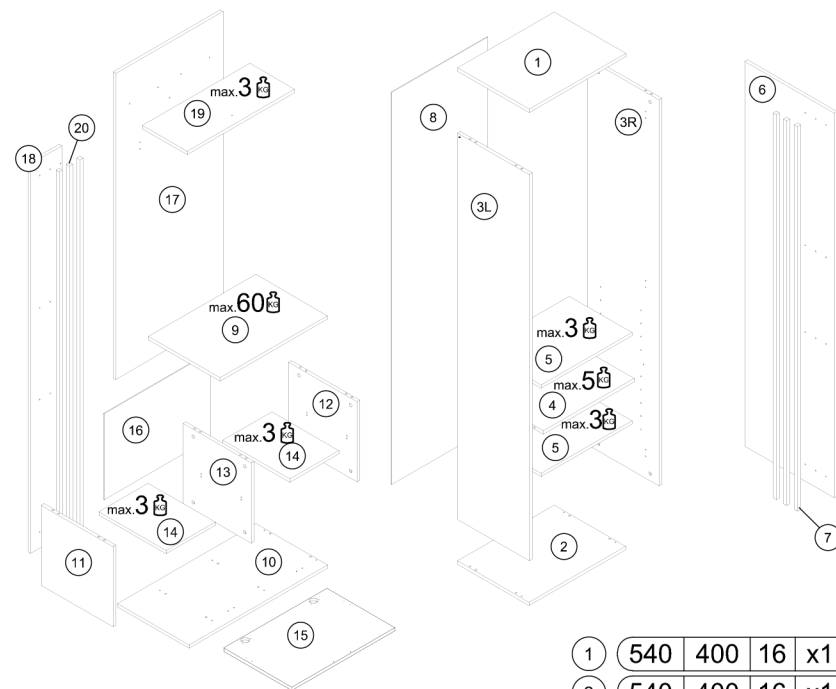

1	540	400	16	x1	2 / 3
2	540	400	16	x1	2 / 3
3L	1868	400	16	x1	1 / 3
3R	1868	400	16	x1	2 / 3
4	508	363	16	x1	3 / 3
5	508	350	16	x2	3 / 3
6	1860	500	16	x1	1 / 3
7	1860	18	18	x3	1 / 3
8	1896	536	2.5	x1	1 / 3
9	600	400	16	x1	2 / 3
10	774	400	16	x1	2 / 3
11	388	400	16	x1	3 / 3
12	388	380	16	x1	2 / 3
13	388	380	16	x1	2 / 3
14	275	375	16	x2	3 / 3
15	380	576	16	x1	3 / 3
16	596	416	2.5	x1	1 / 3
17	1480	600	16	x1	3 / 3
18	1884	174	16	x1	1 / 3
19	600	250	16	x1	3 / 3
20	1884	18	18	x3	1 / 3

A	8x32	B	YD	6,4x60
ZZ	R10	N	ND	3,5x16
K3	M4	O	TA	IMB
NM	Y	W+H2	V	Z
DL	DW	W2	H2	BL

07.06.2022

! **Uwaga • Upozornění • Achtung • Attention • Caution • Figyelem**  
**Attenzione • Opgelet • Внимание • Atenție • Upozornenie • Dikkat** !

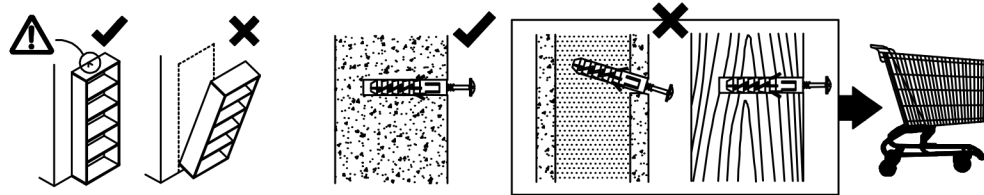
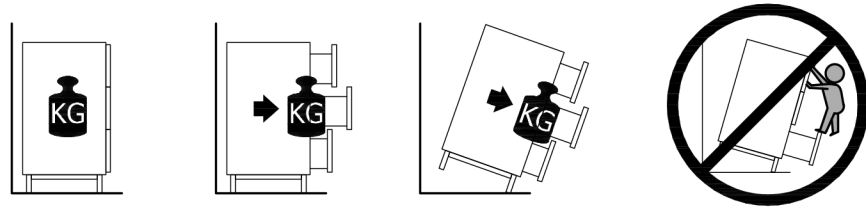

! **Uwaga • Upozornění • Achtung • Attention • Caution • Figyelem**  
**Attenzione • Opgelet • Внимание • Atenție • Upozornenie • Dikkat** !

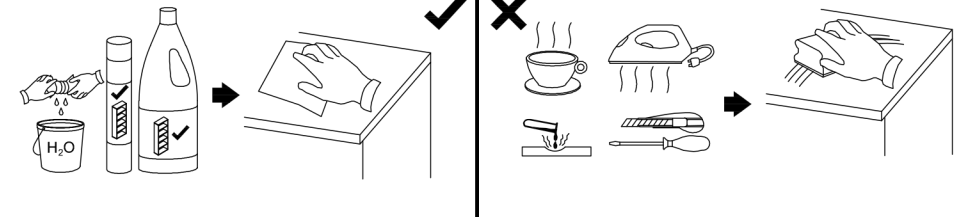
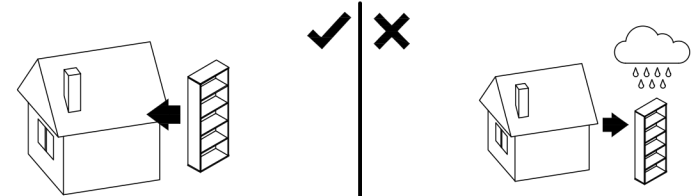

PL	Mocowanie do ściany jest jednocześnie zabezpieczeniem przed przewróceniem - koniecznie zamontować! Do niektórych rodzajów ścian koniecznie zastosować specjalne kołki mocujące.
CZ	Montáž na stěnu slouží jako ochrana proti převrnutí - bezpodmínečně umístěte! U některých typů stěn může být zapotřebí speciální hmoždinka!
DE	Wandbefestigung dient als Kippschutz - unbedingt anbringen! bei einigen Wandtypen kann ein Spezialdübel erforderlich sein!
GB	The wall fastening serves to prevent tipping - be absolutely sure to mount it! For certain wall types, a special wall plug may be necessary!
FR	La fixation murale sert de protection contre le basculement - à installer impérativement! Pour certains types de murs il faut des chevilles spéciales!
NL	Bevestiging aan de muur dient als kantelbescherming - zeker en vast bevestigen! Bij enkele muurtypen is een speciale plug misschien vereist!
IT	Il fissaggio alla parete serve da protezione anti-ribaltamento-attaccarla assolutamente! Per alcune strutture di parete può essere necessario un tassello speciale!
HU	A termék a falhoz kel rögzítési, különben az felborulhat! Egyes fal típusoknál speciális tiplít kell használni!
RU	Обязательно установите крепление на стене во избежание опрокидывания! Для некоторых типов стен может потребо- ваться специальный дюбель!
RO	Sistemul de fixare la perete servește ca protecție la răsturnare - de montat obligatoriu! Pentru unele tipuri de pereți este posibil să fie necesar un diblu special!
SK	Upevnenie na stenu slúži ako ochrana proti prevráteniu - bezpodmienečne použite! Pre niektoré druhy stein môže byť potrebná špeciálna hmoždinka!
TR	Duvardaki sabitleme, devrilmeye karşı bir emniyet tedbiridir ve mutlaka monte edilmelidir! Bazi duvar tiplerinde bunun için özel bir dübel gerekli olabilir!

PL	Czyszczenie należy wykonać wyłącznie za pomocą ściereczki lub lekko nawilżonego ręcznika. Nie stosować środków czyszczących do szorowania.
CZ	Čistění je nutné vykonávat výhradně pomocí utěrky nebo lehce navlhčeného ručníku. Nepoužívejte čističí prostředky obsahující abrazivní částice.
DE	Bitte nur mit einem Staubtuch oder leicht feuchtem Lappen reinigen. Keine scheuernden Putzmittel verwenden.
GB	Please only clean with a duster or damp cloth. Do not use any abrasive cleaners.
FR	Le nettoyage se fait uniquement à l'aide d'un torchon ou d'une serviette légèrement mouillée.
NL	Reinig alleen met een stofdoek of een lichtjes vochtige doek. Gebruik geen schurende poetsmiddelen.
IT	Pulire esclusivamente con un panno o un asciugamano umido.
HU	A tisztítás kizárólag törleruha vagy enyhén nedvesített törölköző segítségével végezhető. Súroló hatású tisztítószereket nem szabad használni.
RU	Очищайте от пыли тряпкой или слегка влажной ветошью. Не допускается применение чистящих средств, не предназначенных для ухода за мебелью.
RO	Curățarea trebuie efectuată numai cu o cârpă sau cu un prosop ușor umezit. Nu utilizați agenți de curățare abrazivi.
SK	Čistenie je nutné vykonávať výhradne pomocou utierky alebo ľahko zvlhnutým ručníkom. Nepoužívajte čistiaci prostriedky obsahujúce abrazívne častice.
TR	Lütfen sadece bir toz bezile veya hafif nemli yumuşak bir bezle siliniz. Aşındırıcı temizlik malzemeleri kullanmayınız.

1

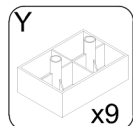
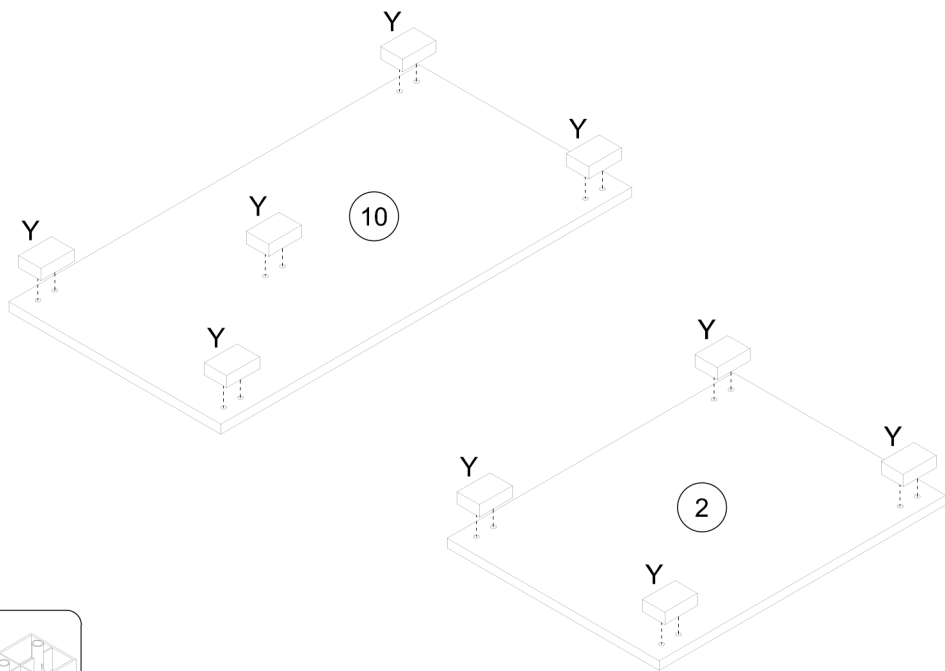

2

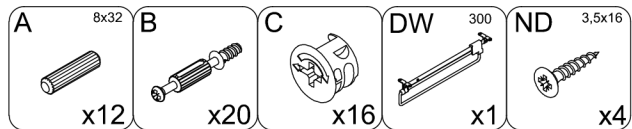
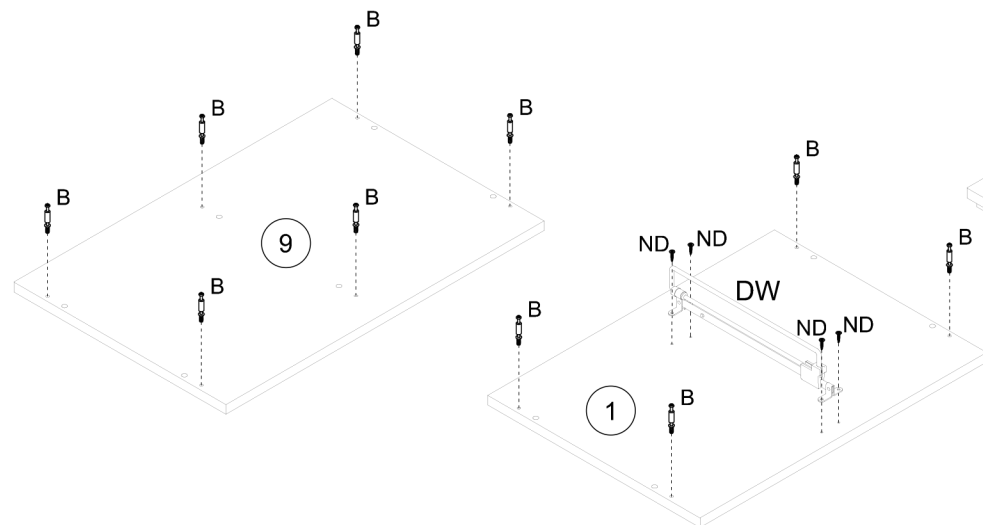
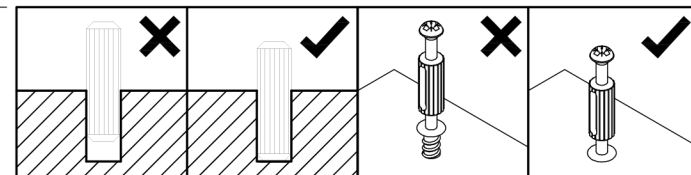

3

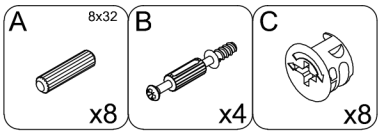
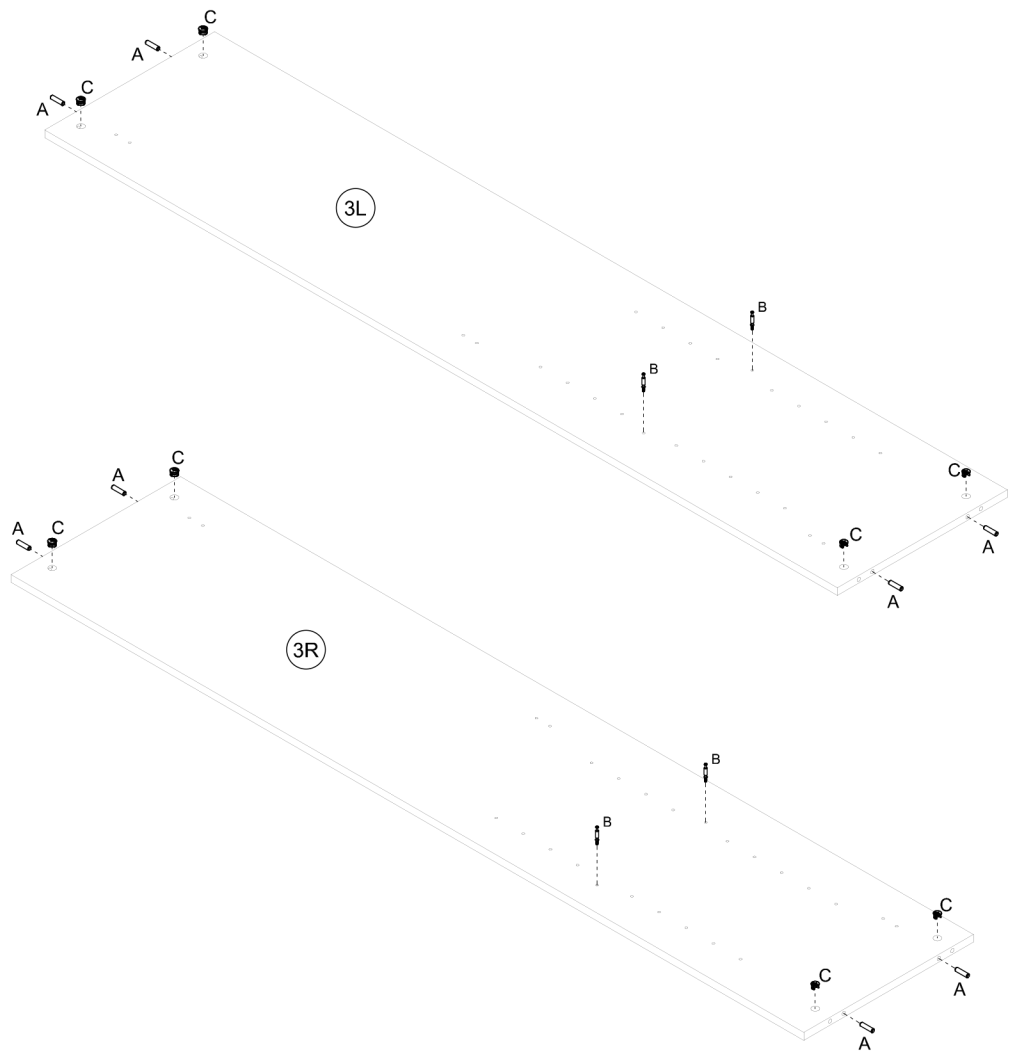
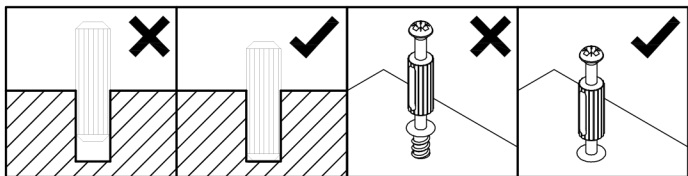

4

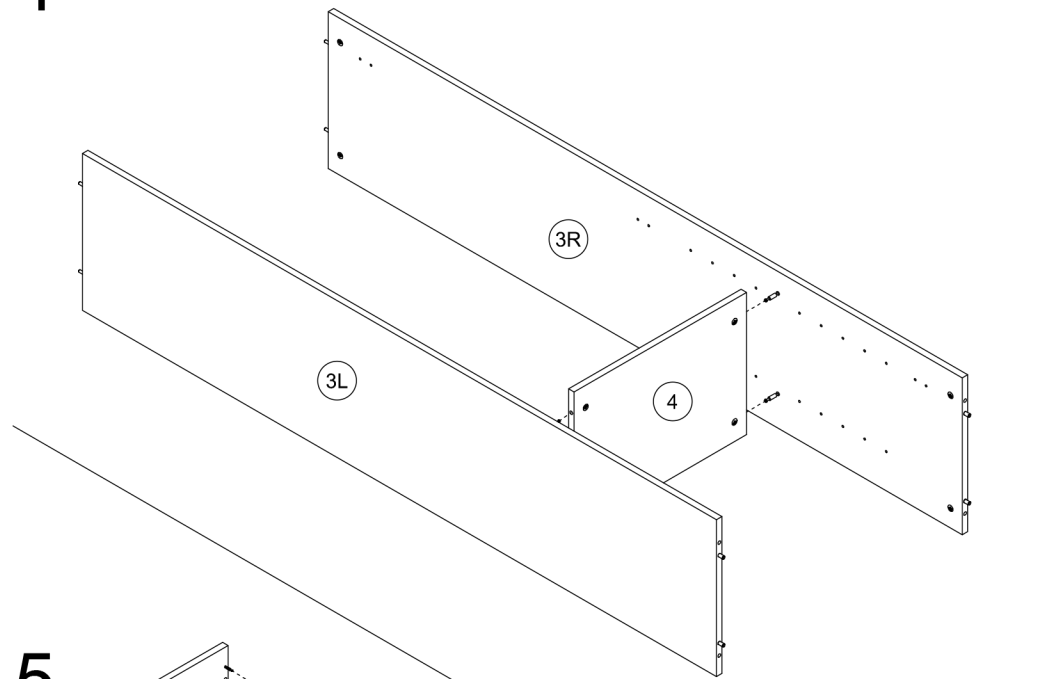

5

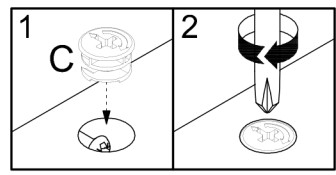
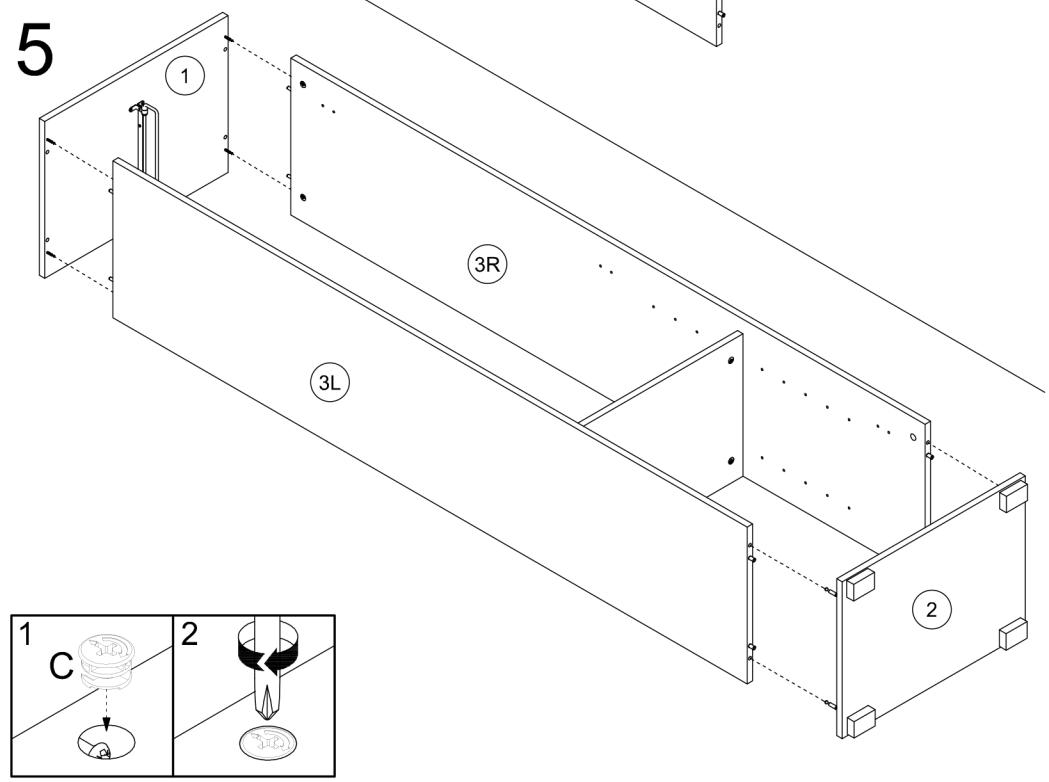

6

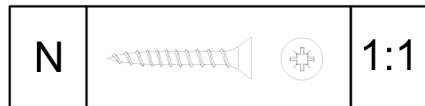
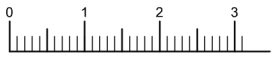
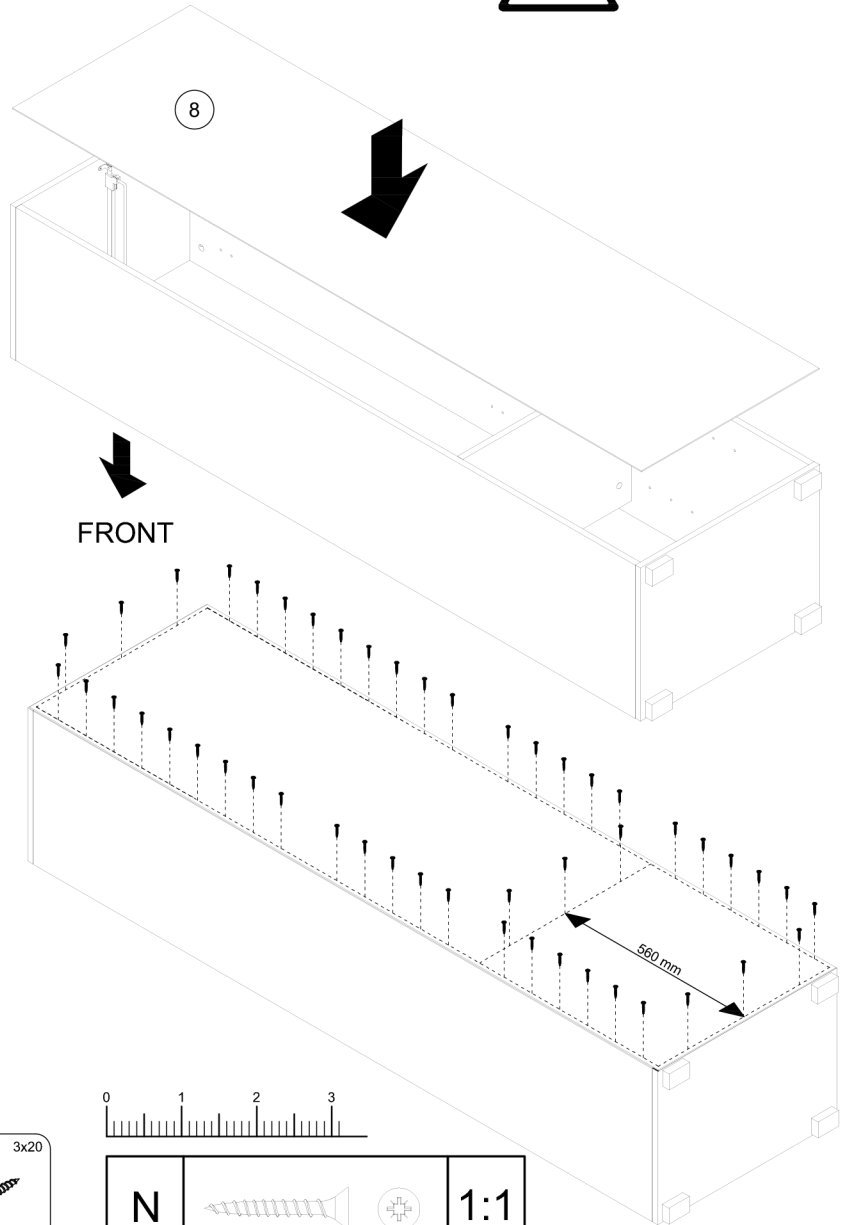
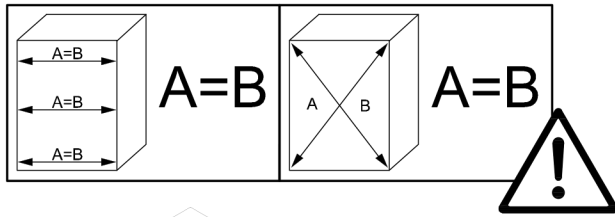

7

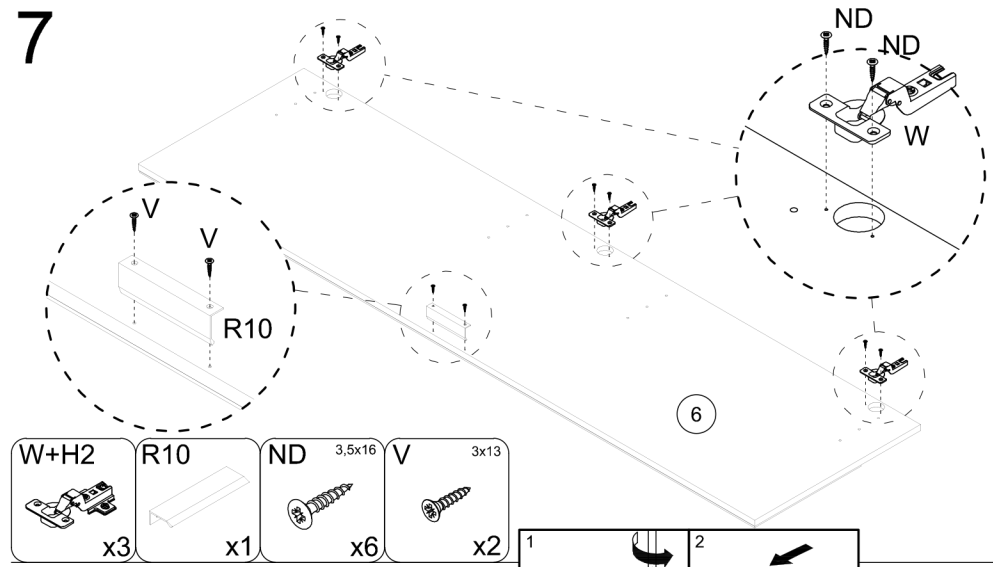

8

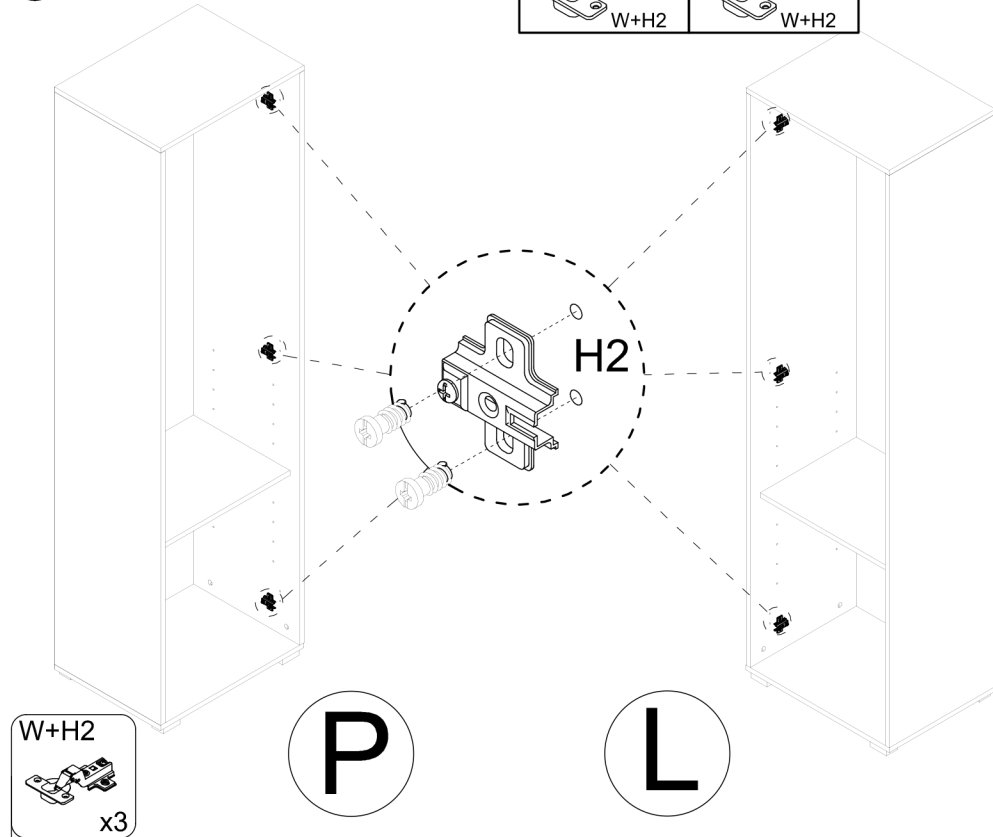

P

L

9

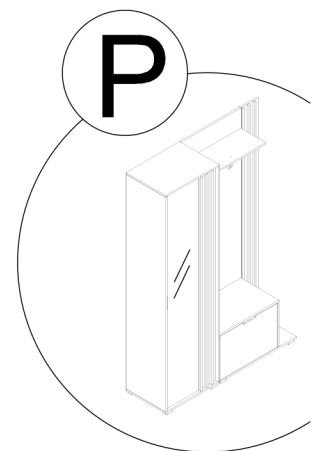
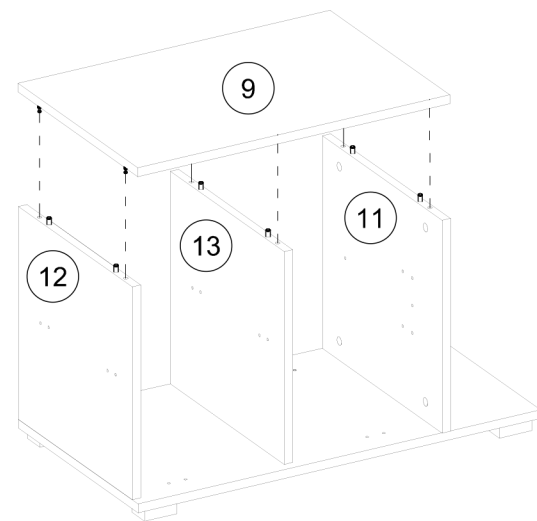
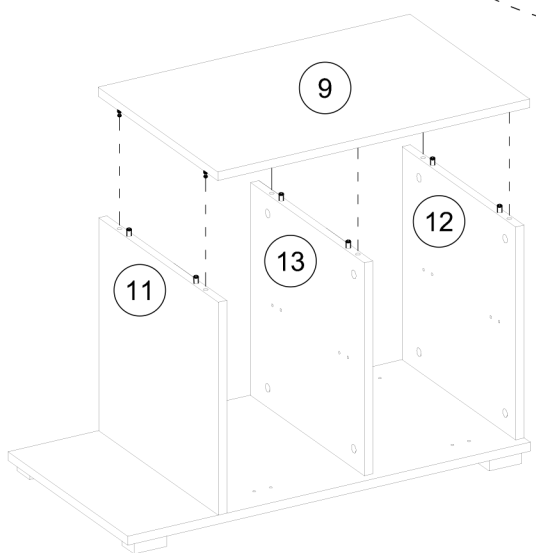
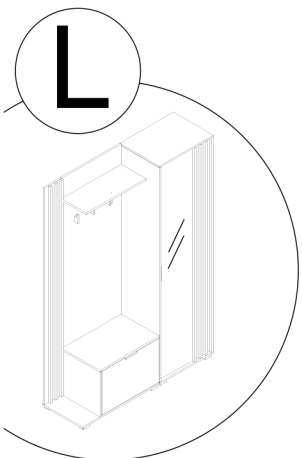
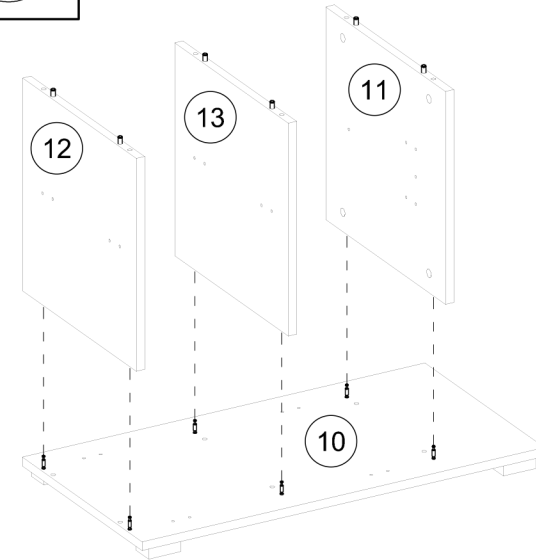
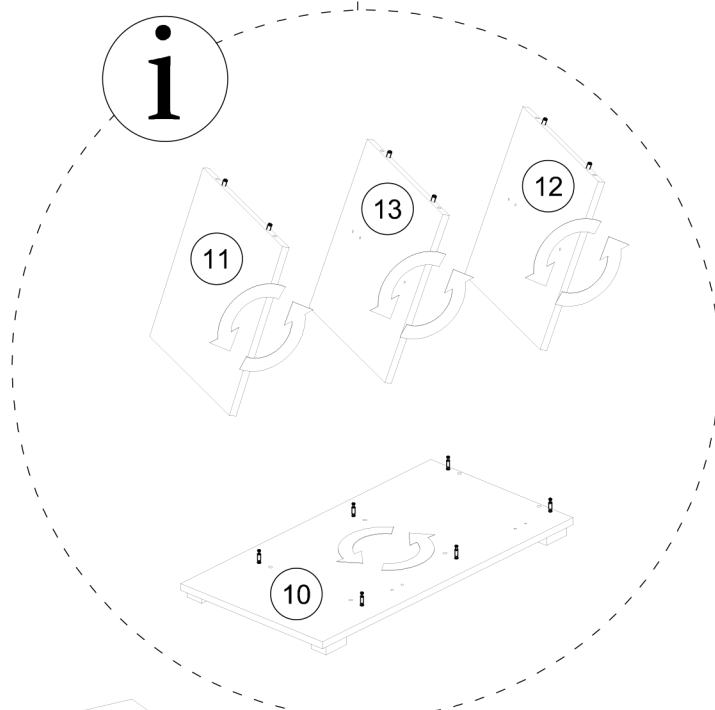
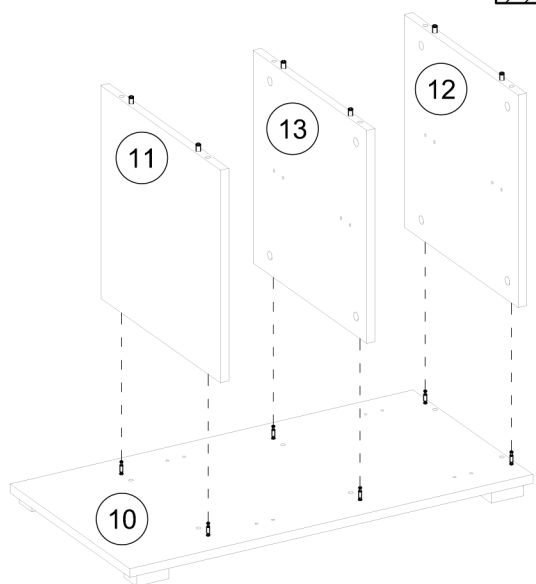
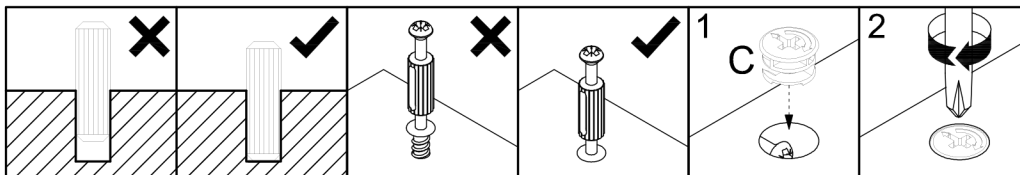

10

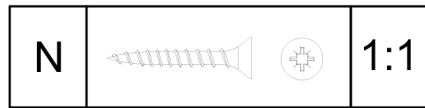
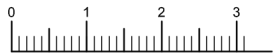
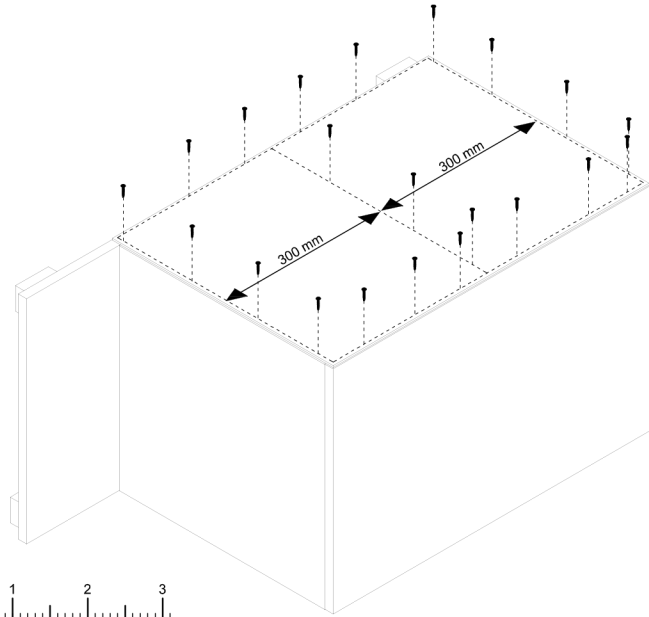
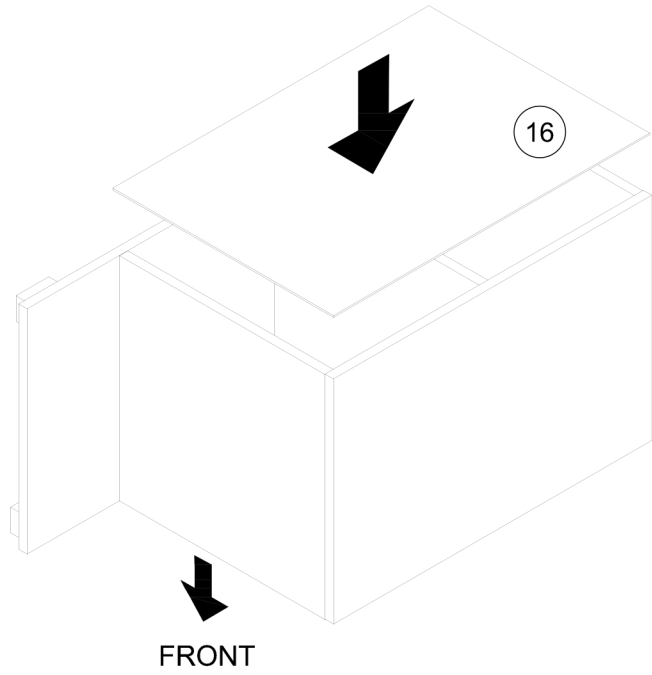

11

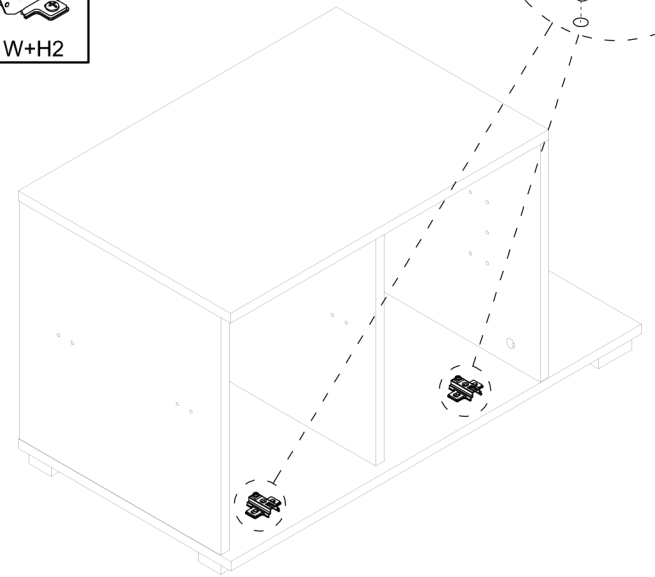
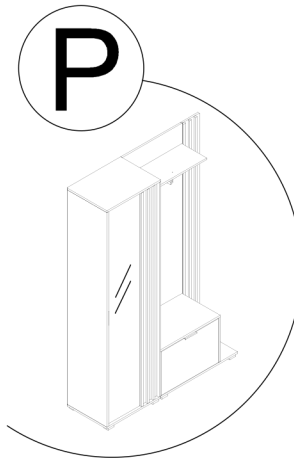
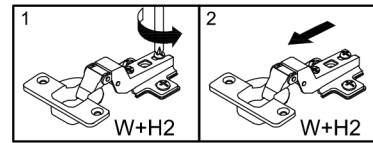
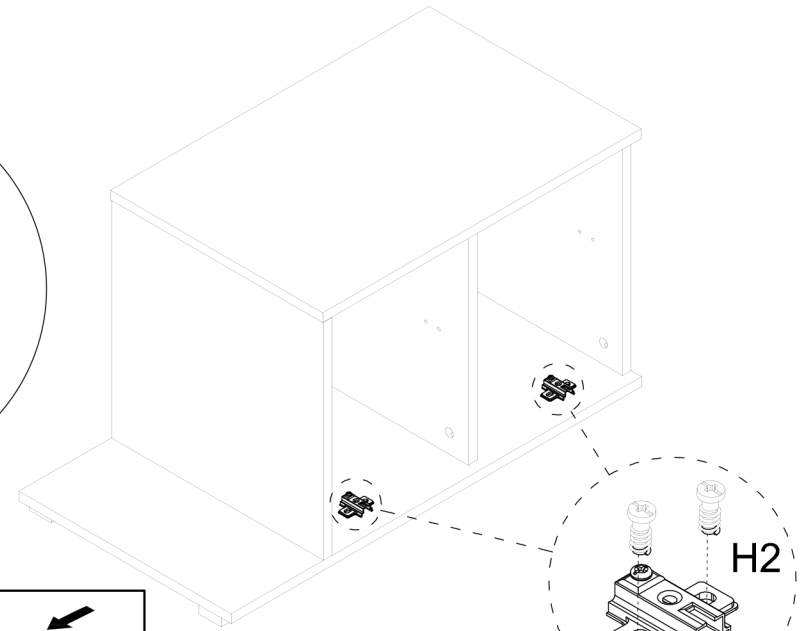
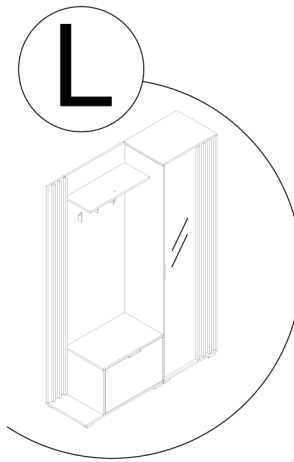



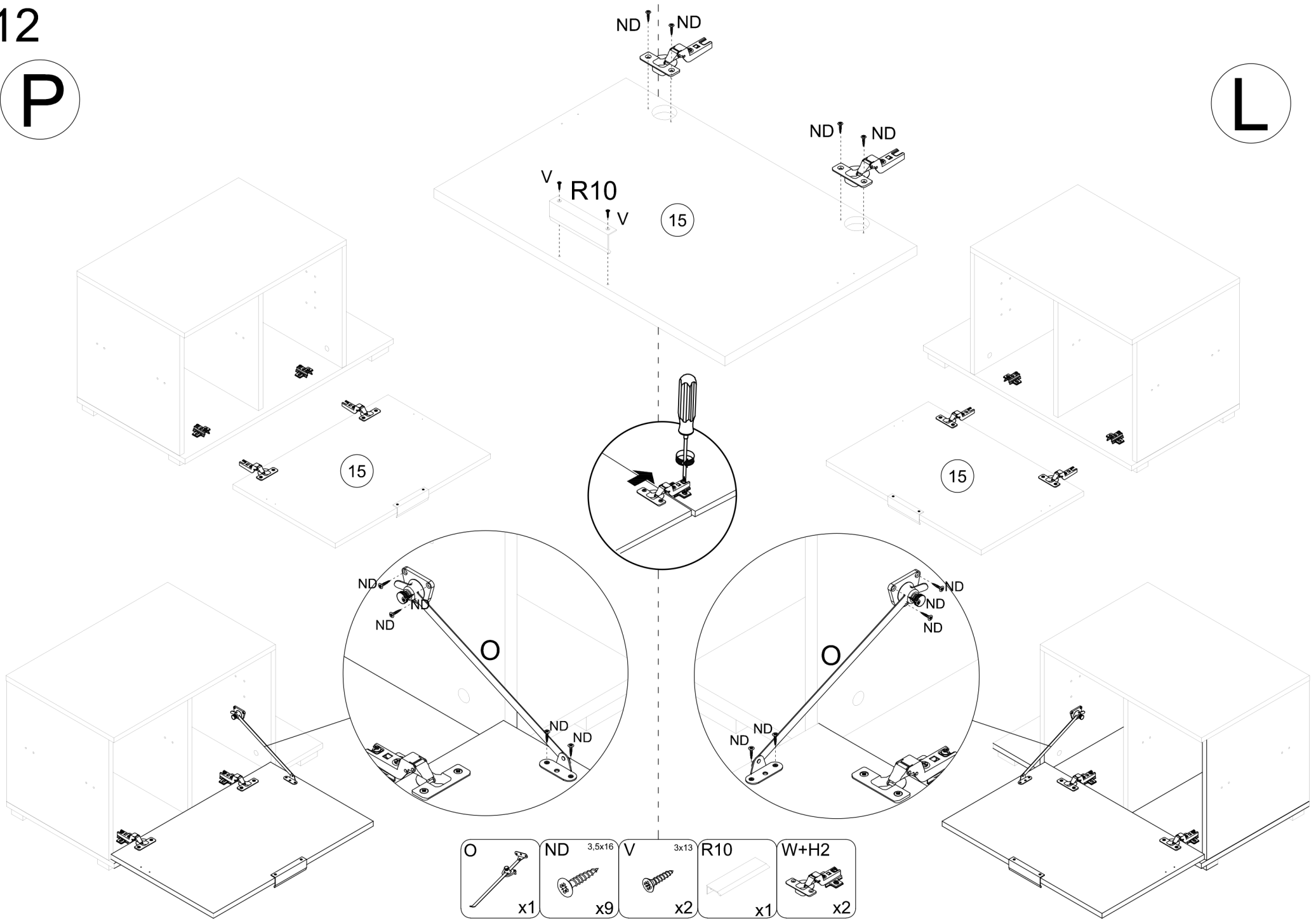

12

P

L



- |   |  |   |   |   |
|---|--|---|---|---|
| O   | ND 3,5x16  | V 3x13  | R10   | W+H2  |
|  |  |  |  |  |
| x1  | x9   | x2  | x1  | x2  |



13

P

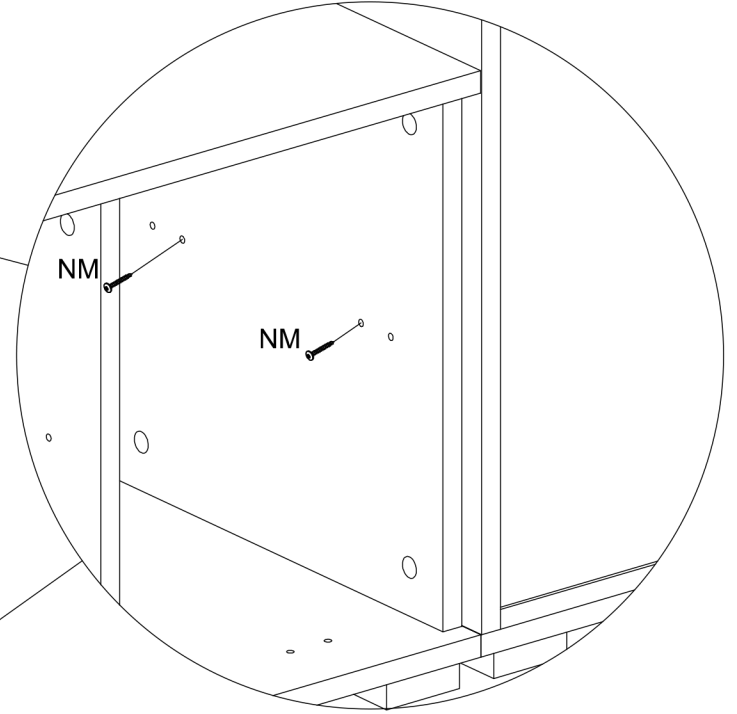
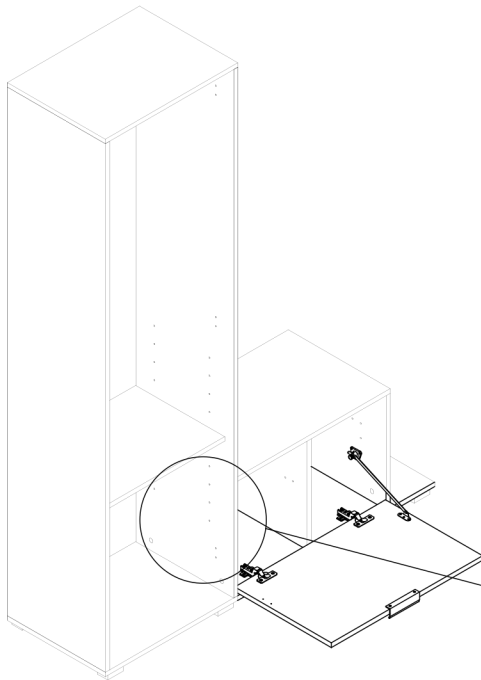
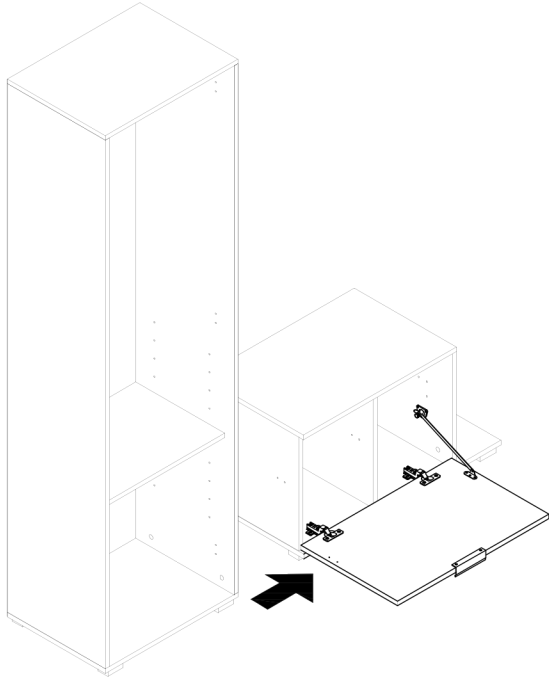

L

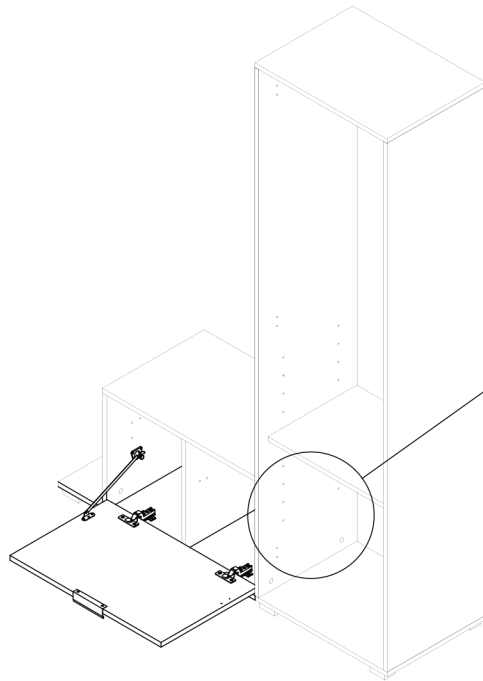
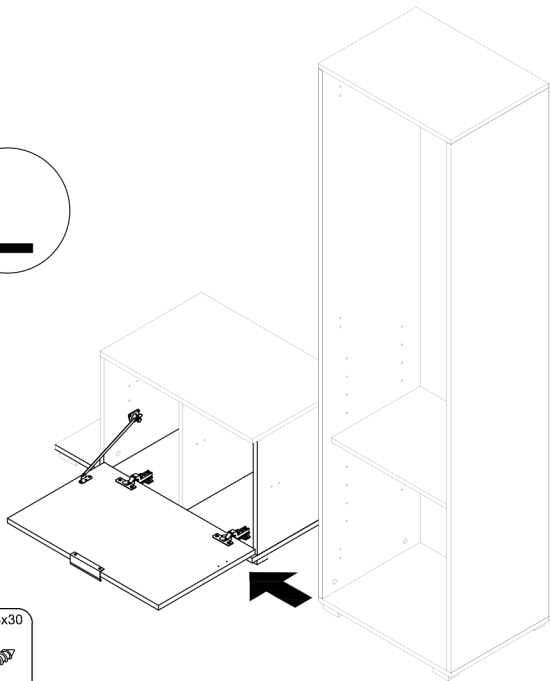

# 14

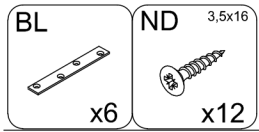
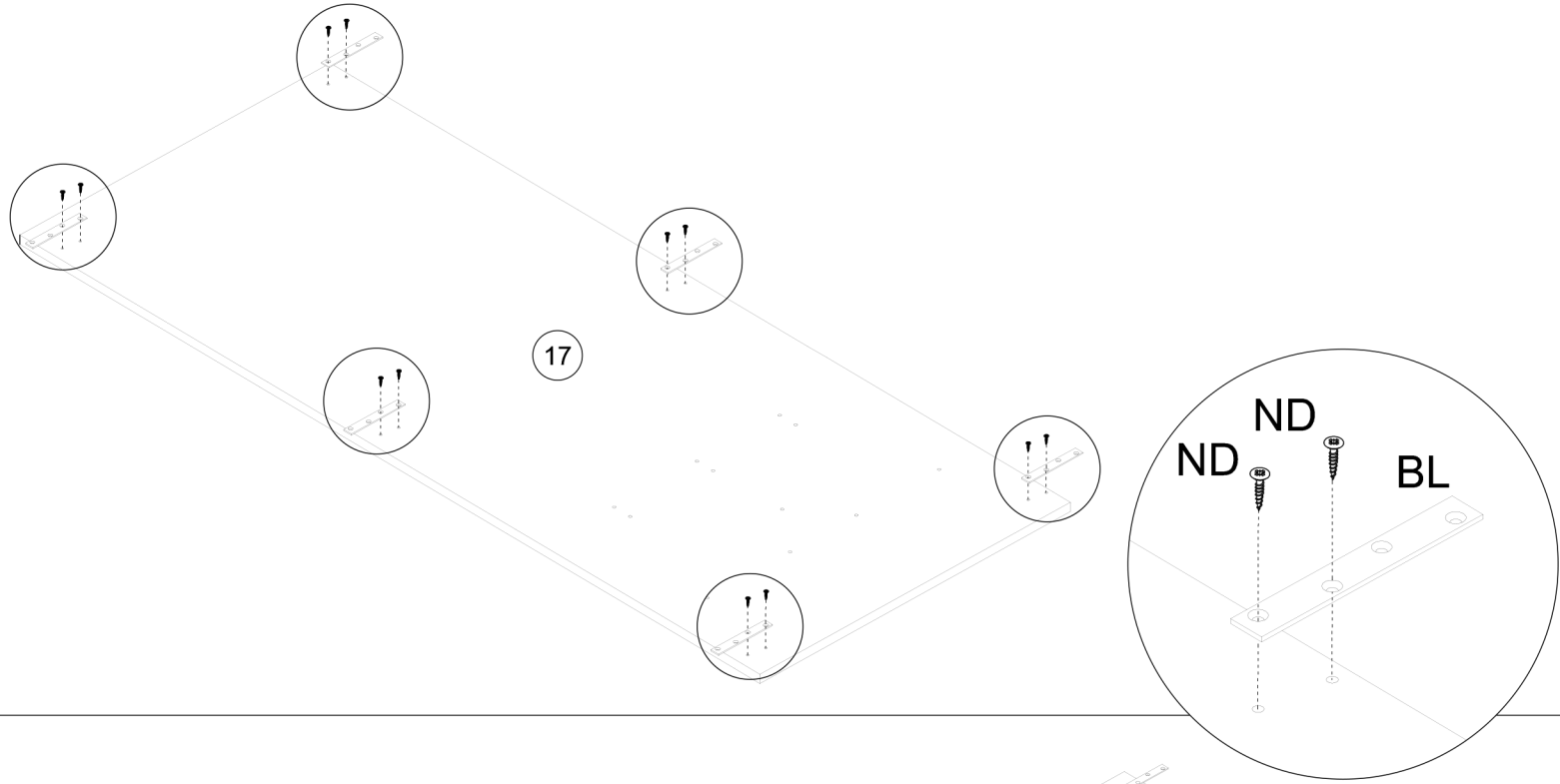

# 15

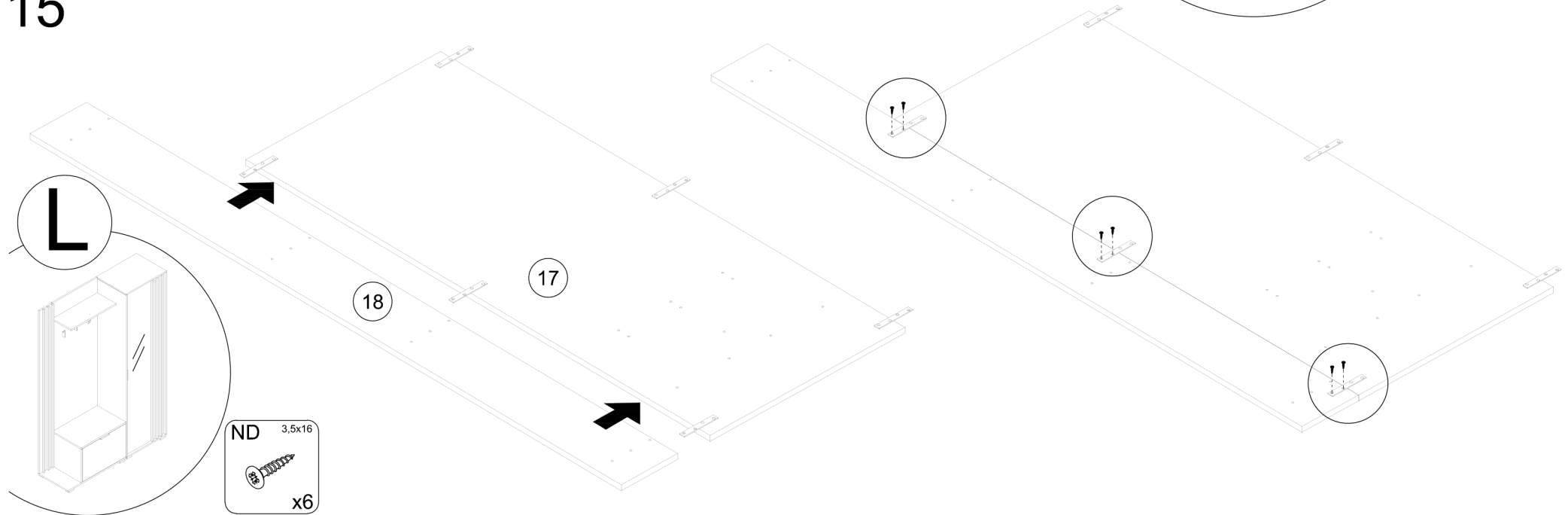

16

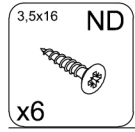
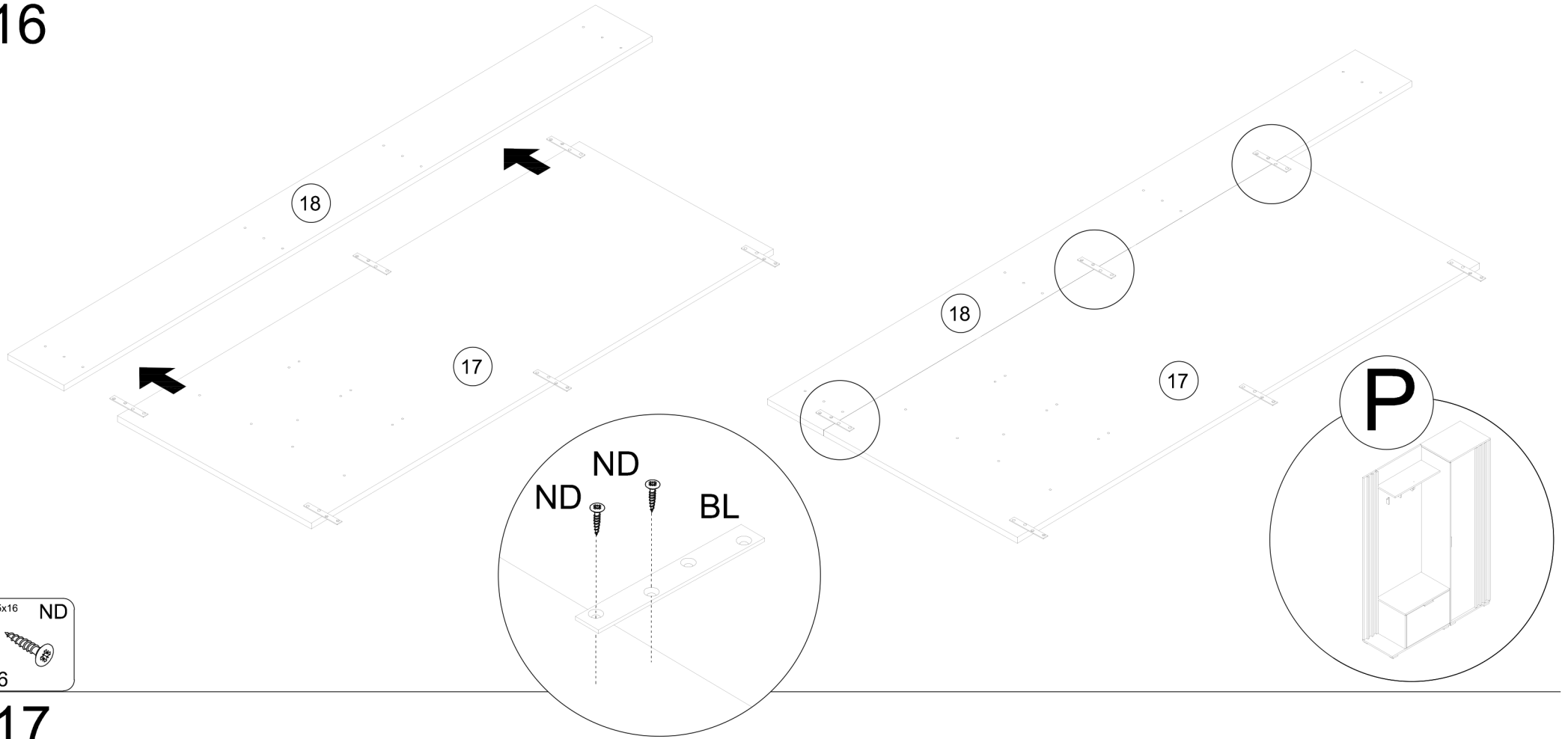

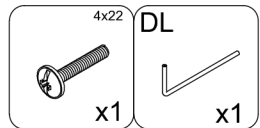
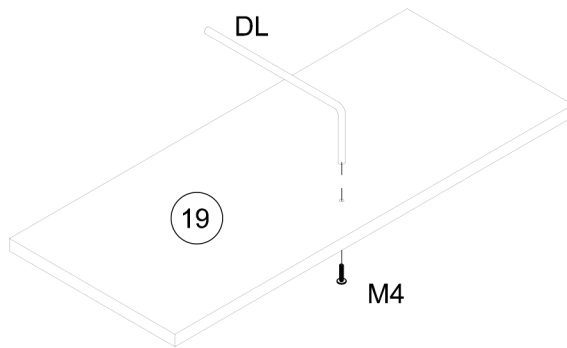

17

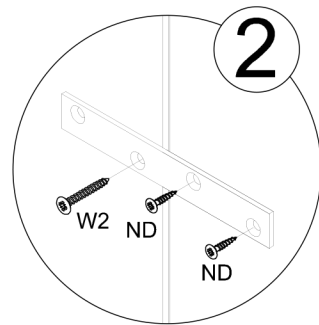
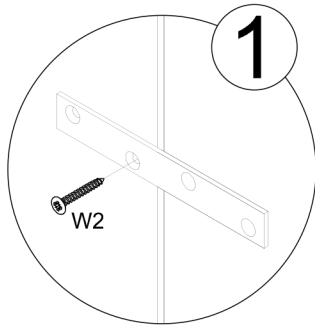
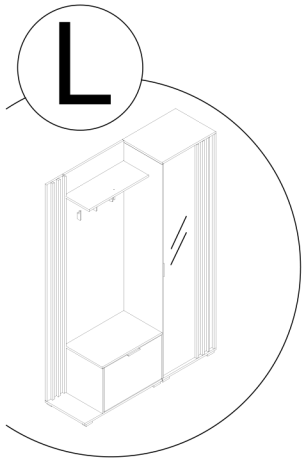
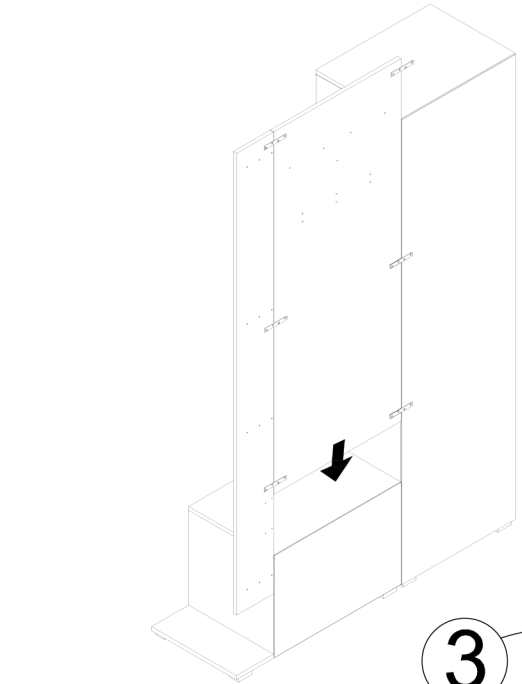
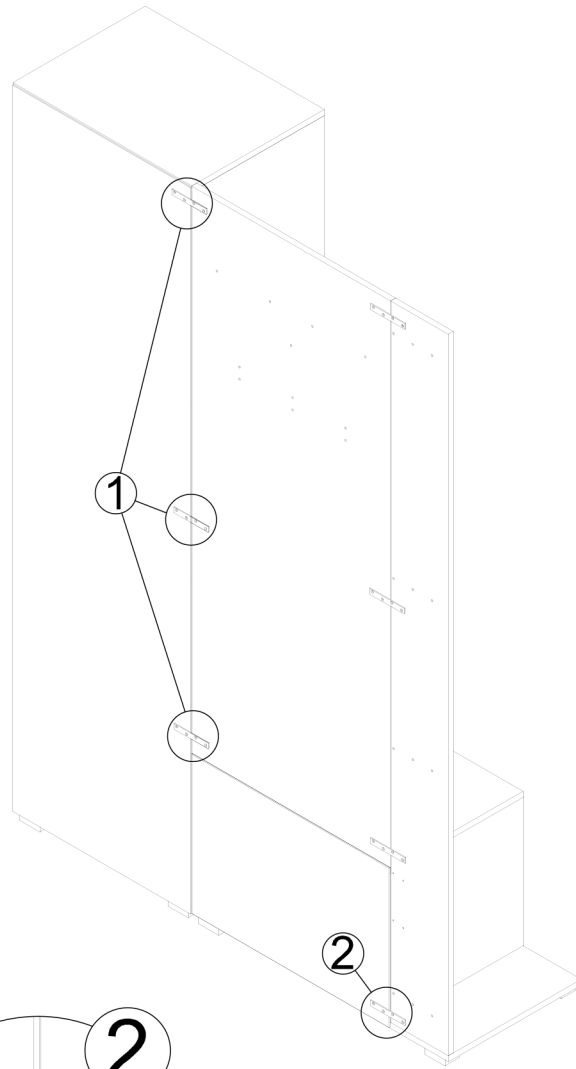
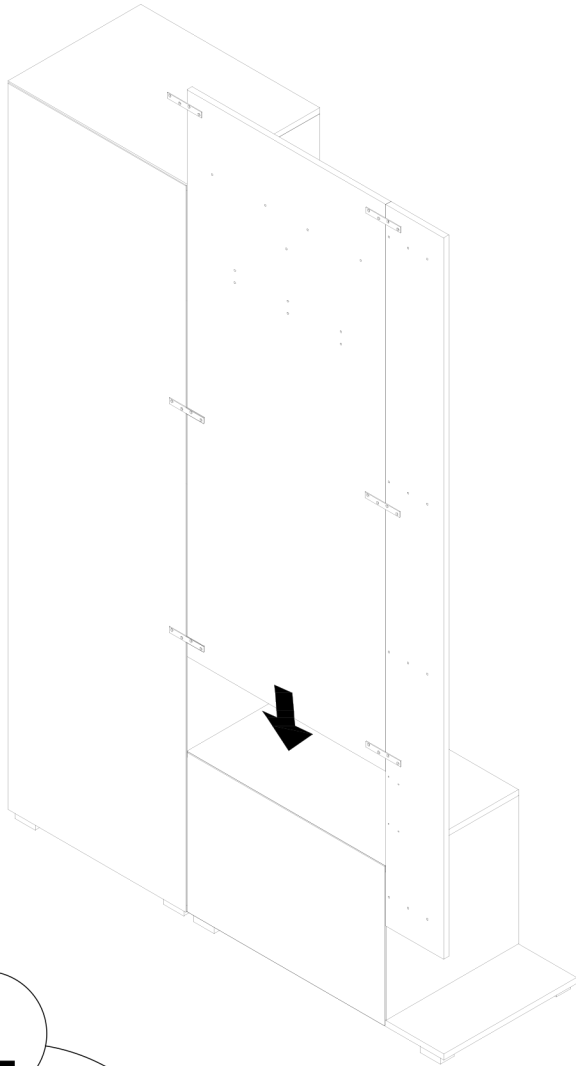

18



BL	ND 3,5x16	W2 4x30
		
x1	x2	x4

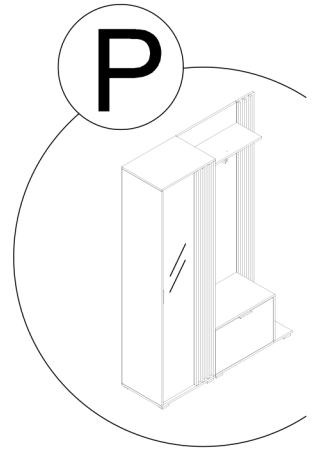
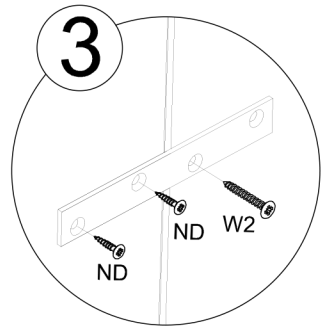

# 19

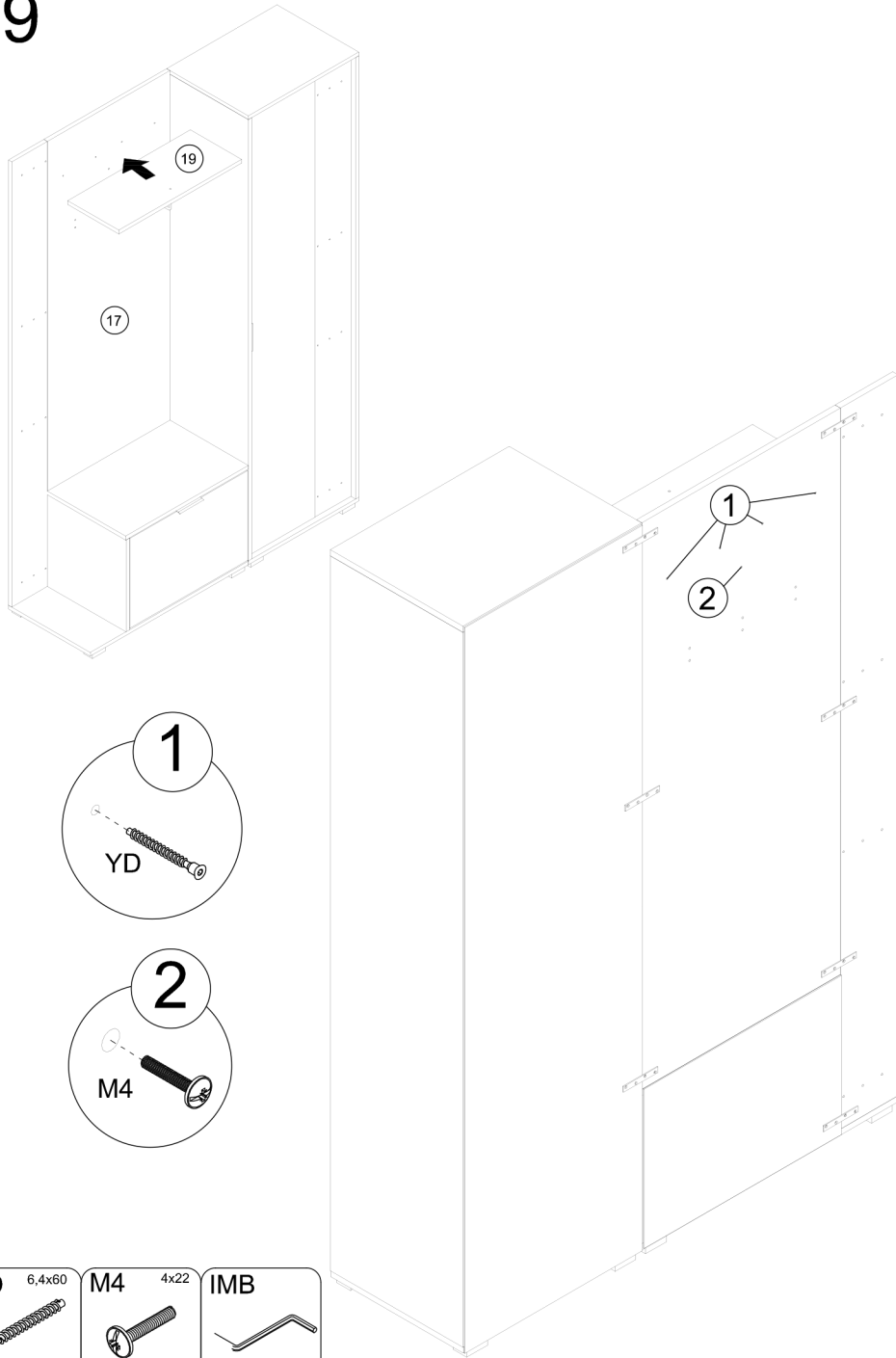

# 20

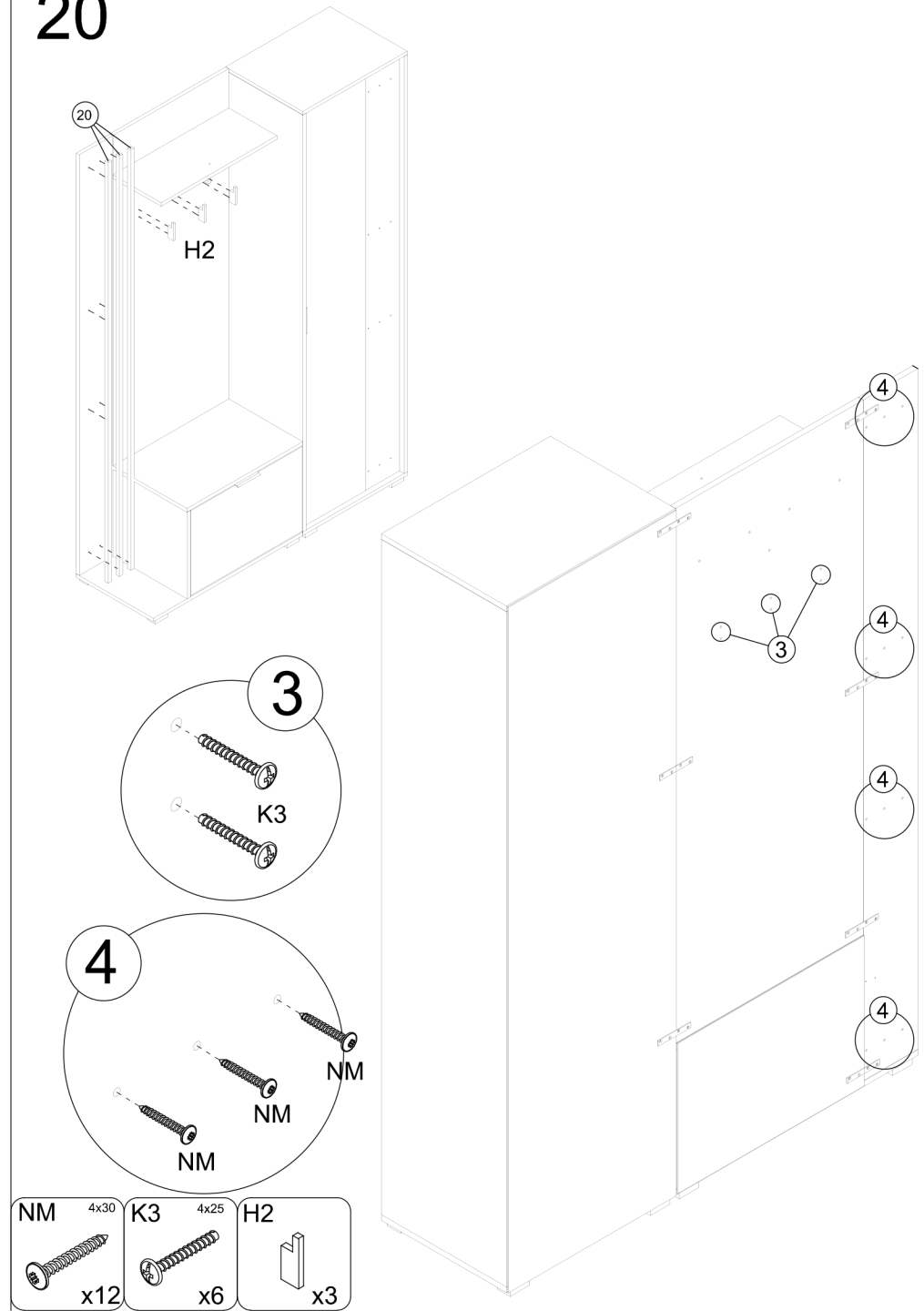

21

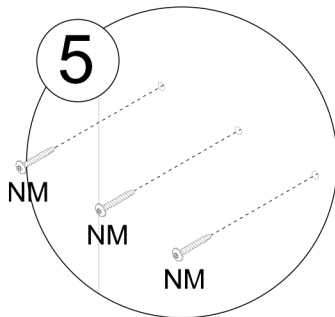
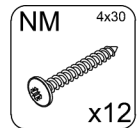
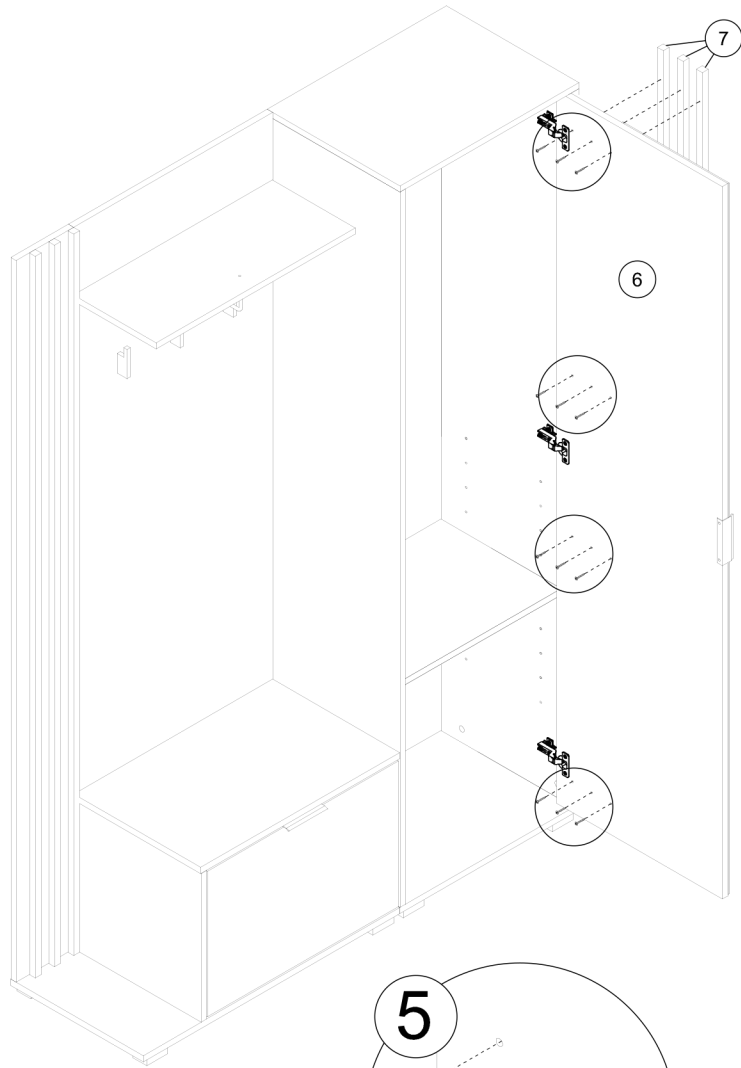

22

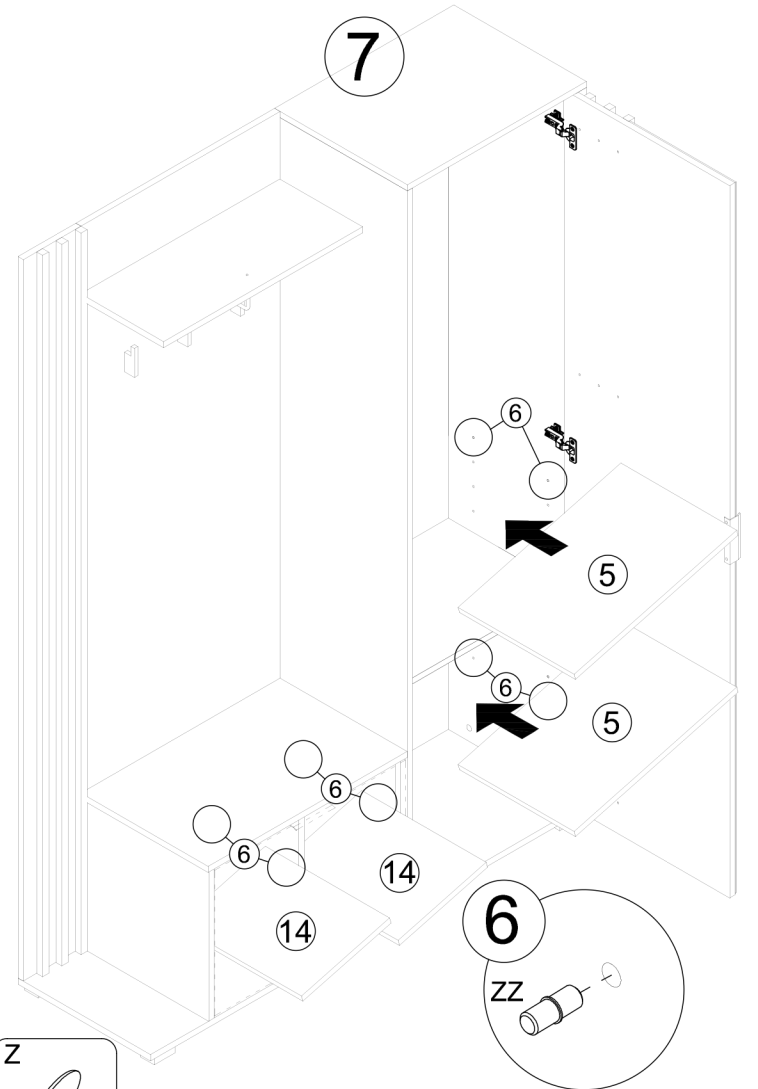
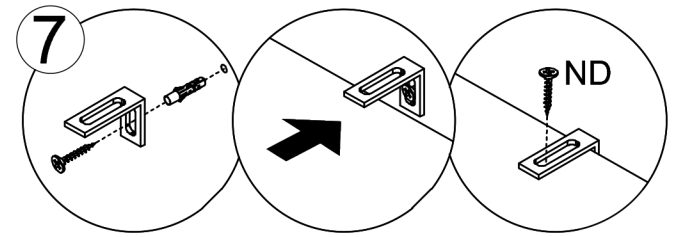
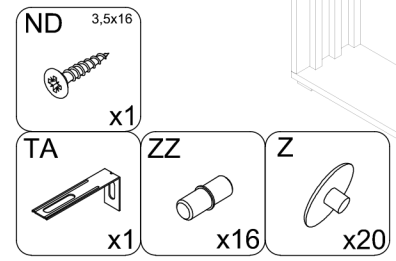
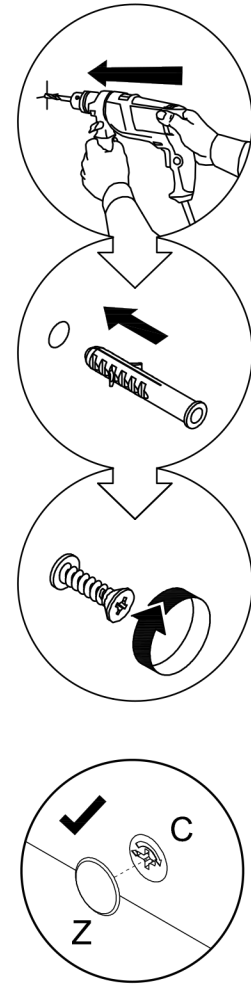

7

6

