

INSTRUKCJA MONTAŻU

FITTING-UP INSTRUCTION / AUFBAUANLEITUNG
MONTÁŽNÍ NÁVOD / MONTÁŽNY NÁVOD

Producent:
Restol sp. z o.o.
36-055 BRATKOWICE
www.restol.com.pl

Theo THTV-2

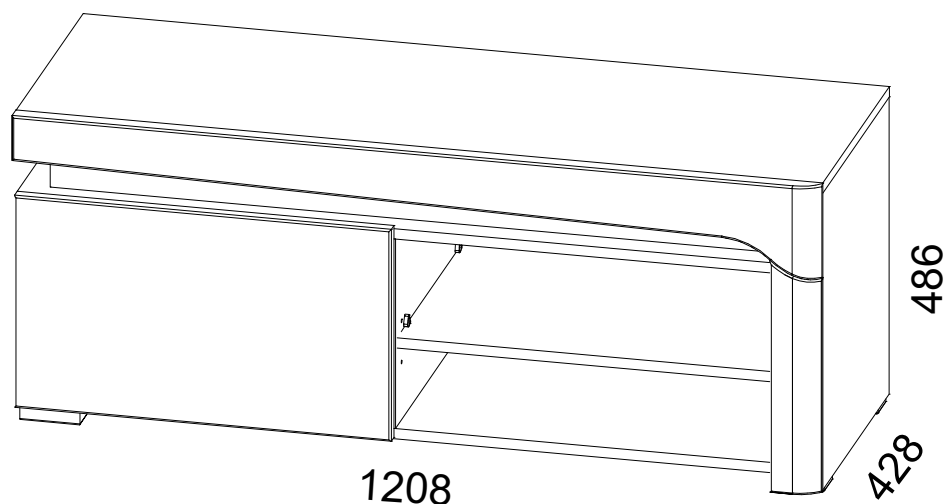

1208 x 486 x 428 /mm/

POKYN pro ošetřování nábytku!

Díly čistit vlhkým hadříkem nebo papírovou utěrkou.

Nepoužívat chemické čisticí prostředky.

POKYNY k údržbě nábytku.

Prvky nábytku čistit vlhkou handričkou alebo papírovou utěrkou.

Nepoužívat chemické čistiace prostriedky.

WSKAZÓWKA na temat pielęgnacji mebla.

Czyścić elementy wilgotną szmatką lub papierowym ręcznikiem.

Nie używać chemicznych środków czyszczących.

DIRECTION for the furniture cleaning.

Clean elements with the moist wiper or soft paper towel. Do not use any detergents.

Pflegehinweis.

Nur mit feuchtem Lappen, bzw. Papiertuch Ihre Möbel reinigen. Keine chemischen Waschmittel einsetzen.

INSTRUKCJA MONTAŻU
FITTING-UP INSTRUCTION / AUFBAUANLEITUNG
MONTÁŽNÍ NÁVOD / MONTÁŽNY NÁVOD

Theo THTV-2



Do montażu potrzebne są:
You need for fitting-up:
Zur Montage werden Sie brauchen:
K montáži jsou potřebné:
Na montáž potrebujete:

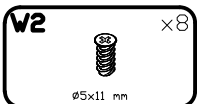
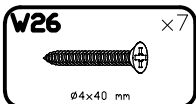
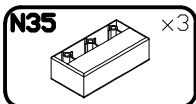
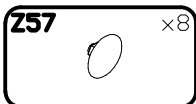
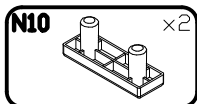
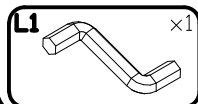
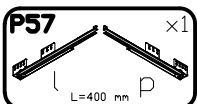
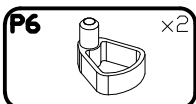
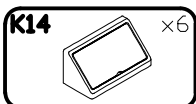
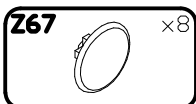
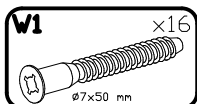
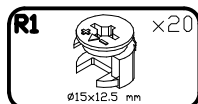
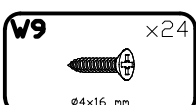
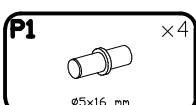
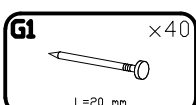
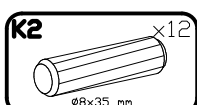
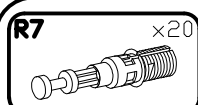
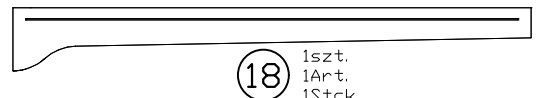
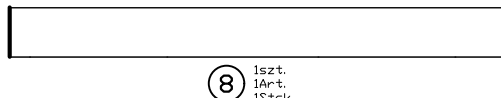
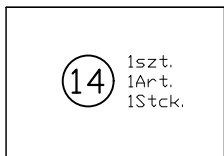
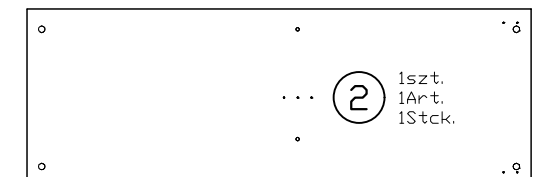
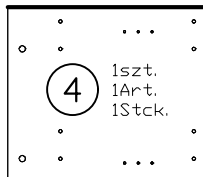
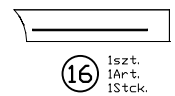
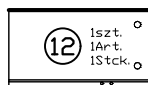
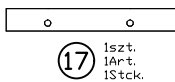
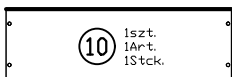
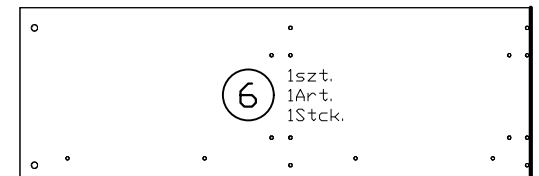
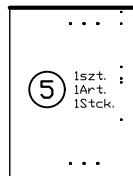
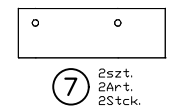
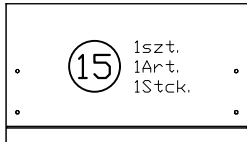
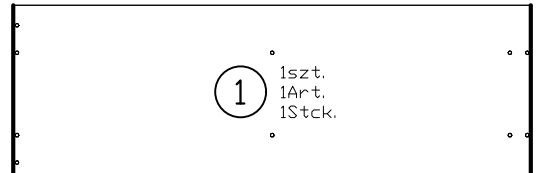
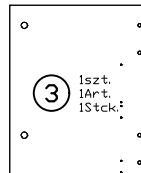
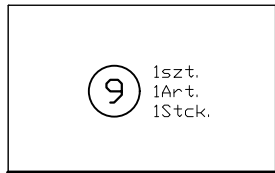
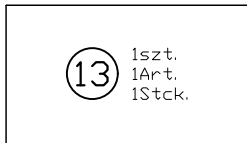
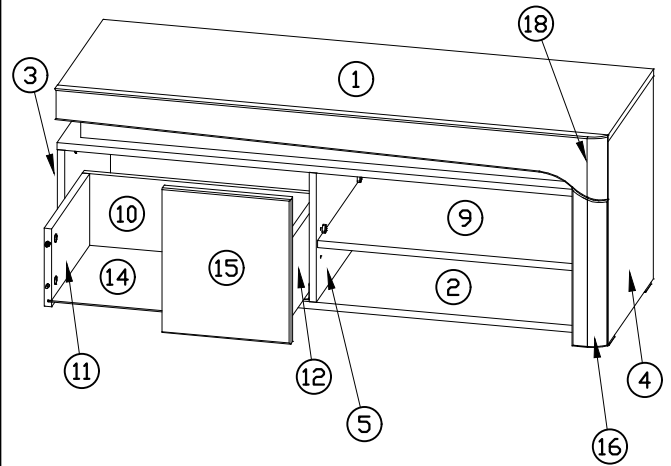
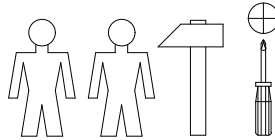

PODCZAS MONTAŻU POSTĘPOWAĆ ZGODNIE Z INSTRUKCJĄ
 WHILE ASSEMBLING FOLLOW THE INSTRUCTION / MONTAGE LAUT DER AUFBAUANLEITUNG DURCHFÜHREN
 PŘI MONTÁŽI POSTUPOVAT PODLE NÁVODU / PRI MONTÁŽI POSTUPUJTE PODĽA NÁVODU

1^{THco} THTV-2

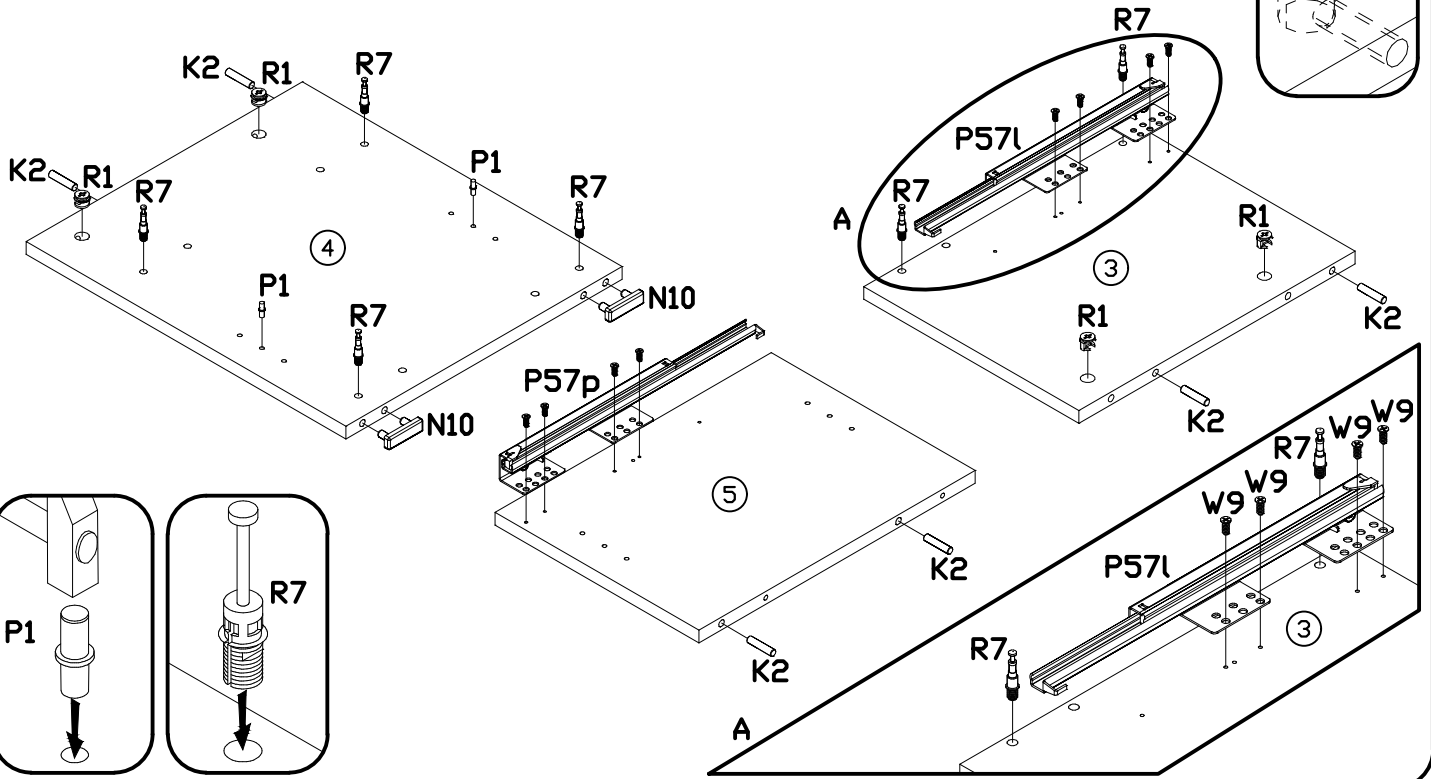
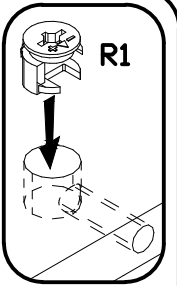
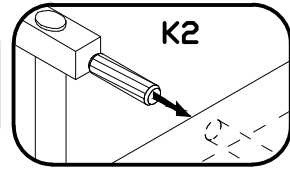
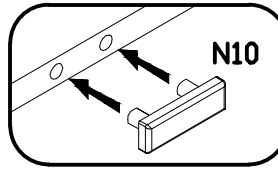

2^{THco} THTV-2

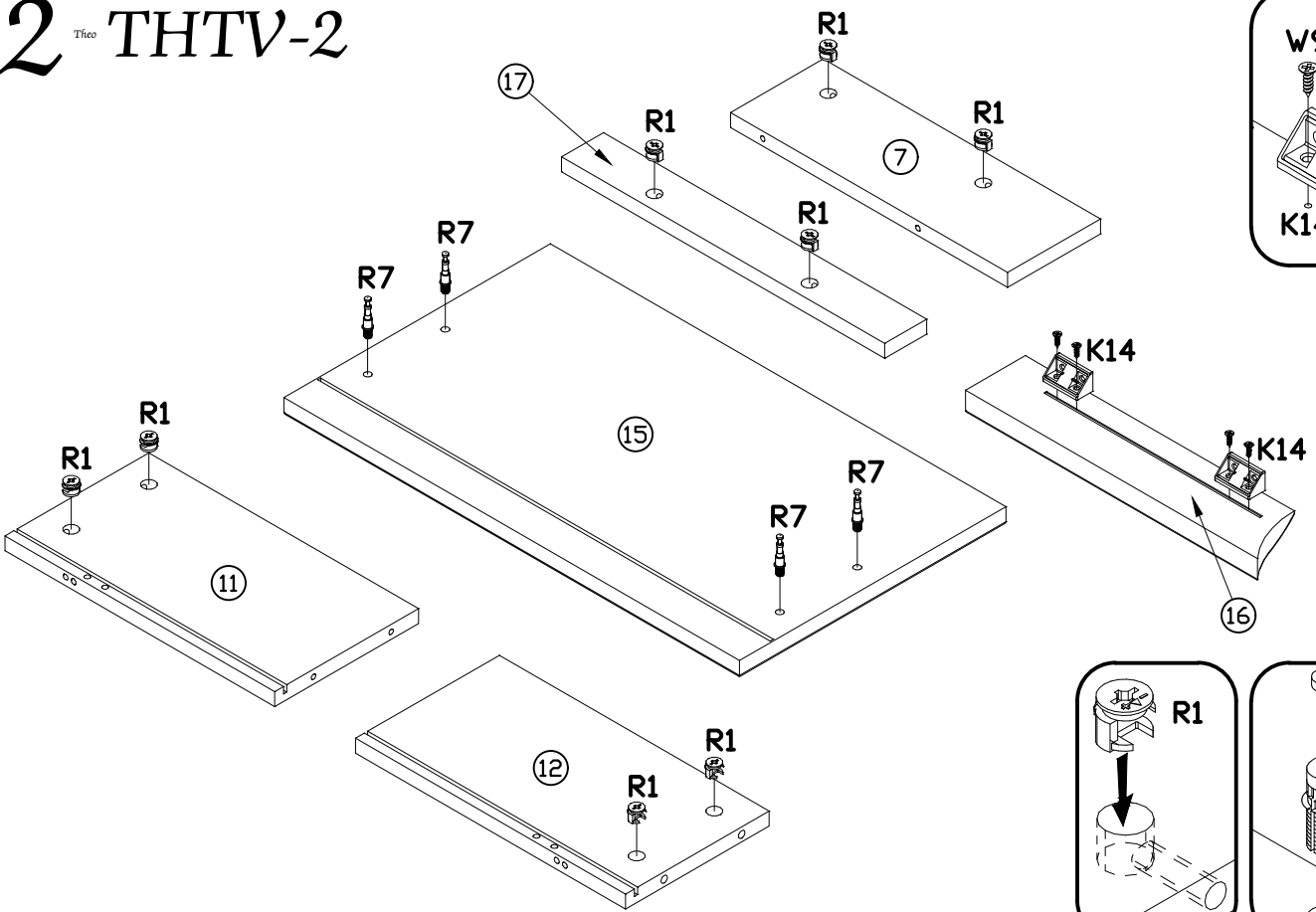
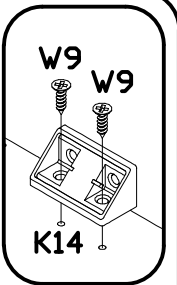

PODCZAS MONTAŻU POSTĘPOWAĆ ZGODNIE Z INSTRUKCJĄ
 WHILE ASSEMBLING FOLLOW THE INSTRUCTION / MONTAGE LAUT DER AUFBAUANLEITUNG DURCHFÜHREN
 PŘI MONTÁŽI POSTUPOVAT PODLE NÁVODU / PRI MONTÁŽI POSTUPOJTE PODĽA NÁVODU

5^{theo} THTV-2 - Opcja NEO-8

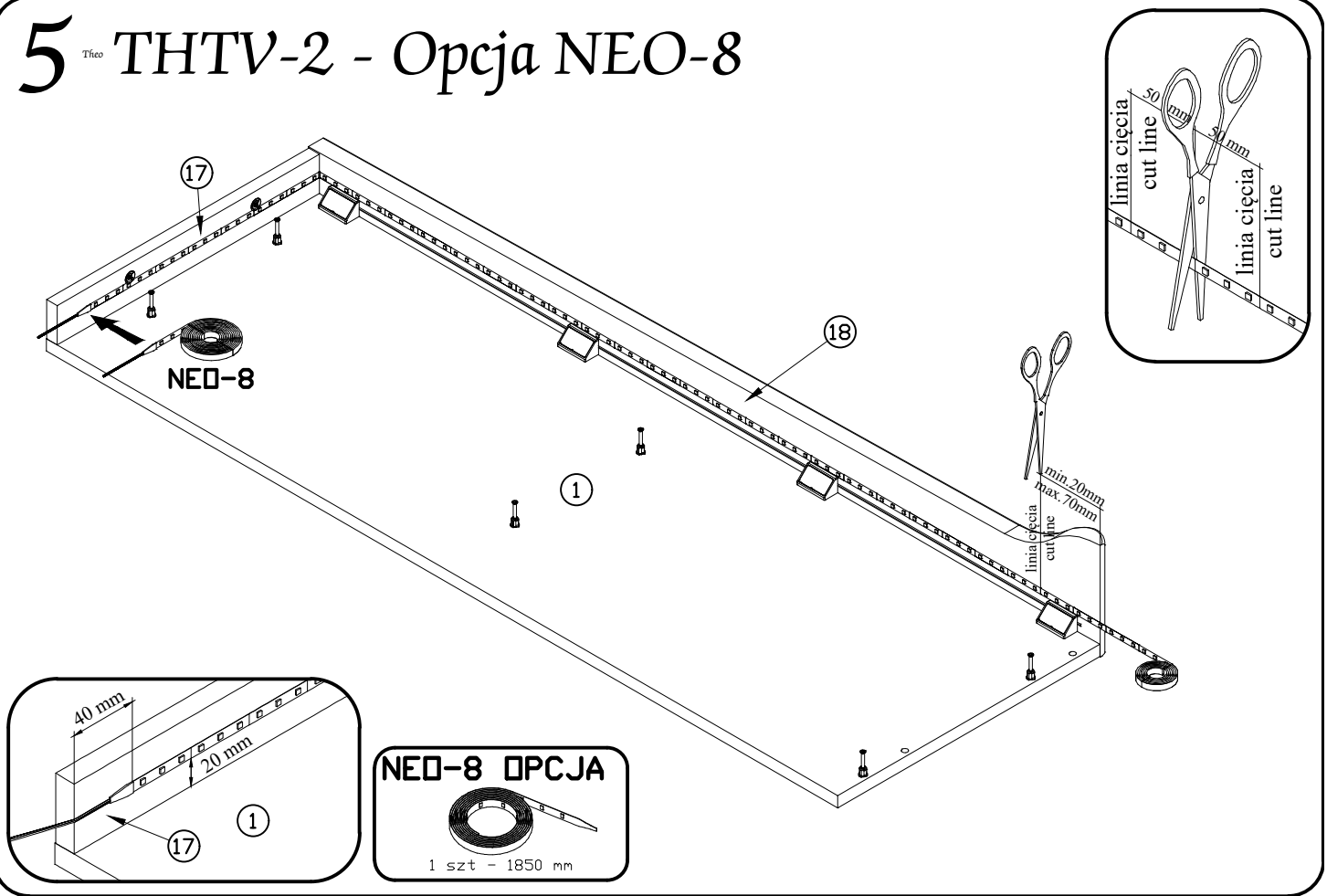

6^{theo} THTV-2

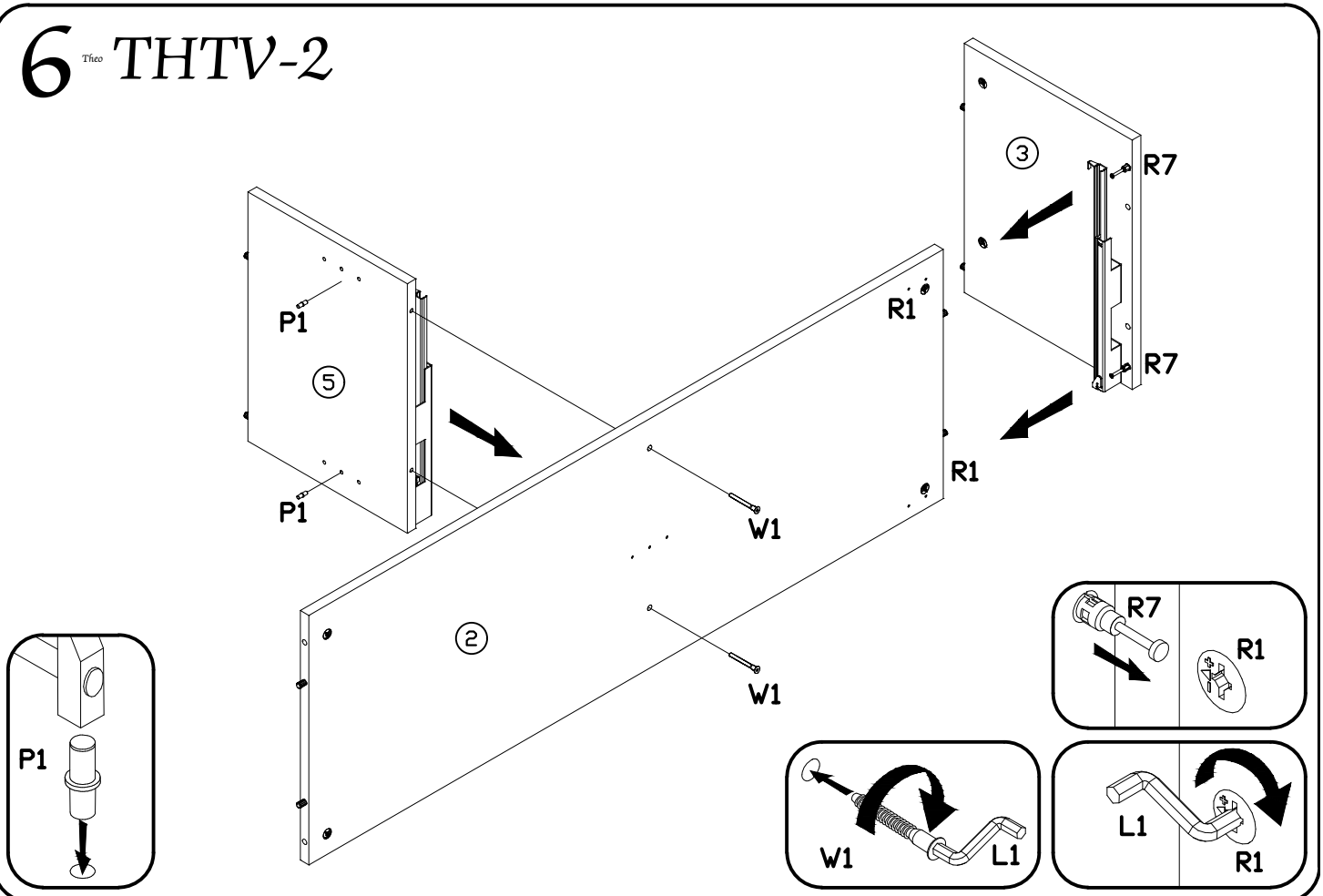

PODCZAS MONTAŻU POSTĘPOWAĆ ZGODNIE Z INSTRUKCJĄ
WHILE ASSEMBLING FOLLOW THE INSTRUCTION / MONTAGE LAUT DER AUFBAUANLEITUNG DURCHFÜHREN
PŘI MONTÁŽI POSTUPOVAT PODLE NÁVODU / PRI MONTÁŽI POSTUPOJTE PODĽA NÁVODU

7TH THTV-2

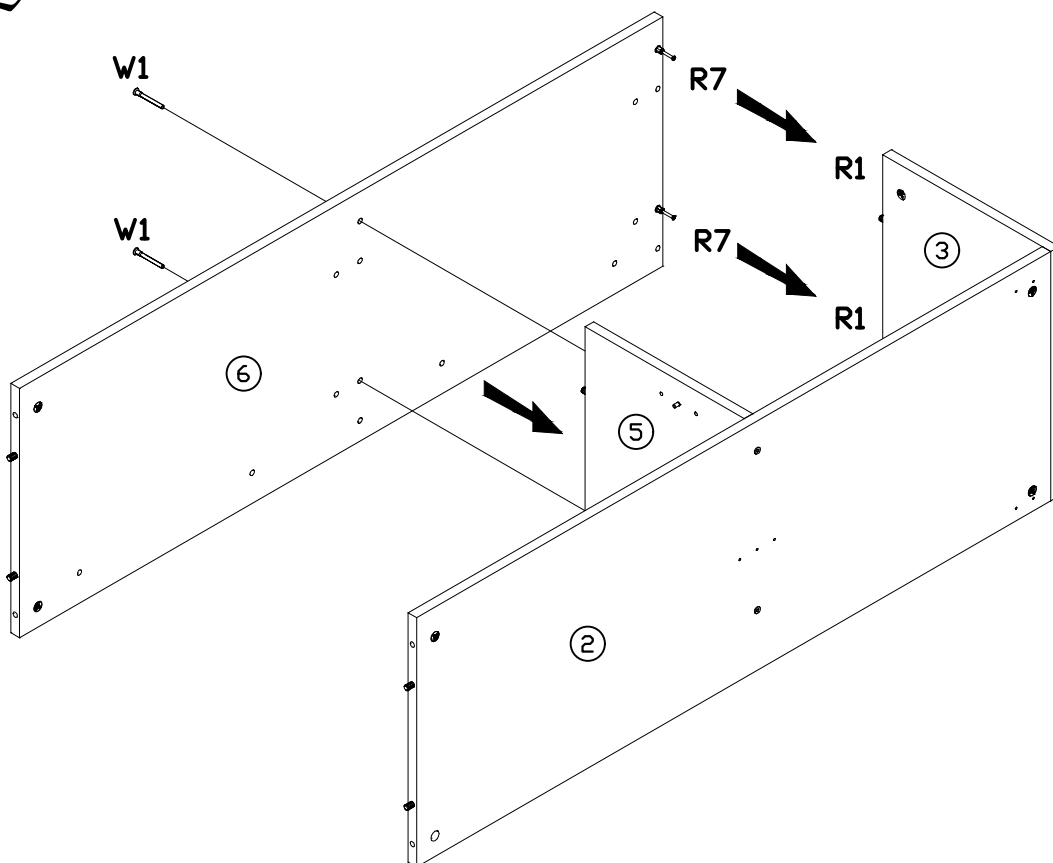
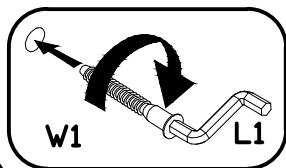
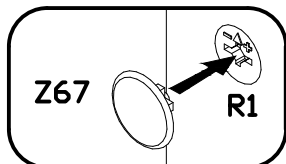
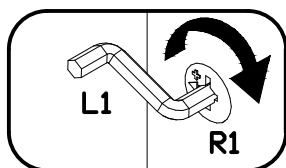
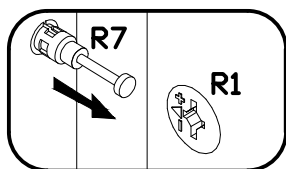

8TH THTV-2

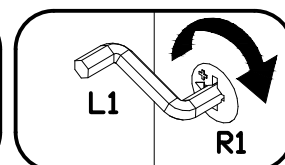
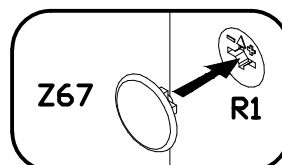
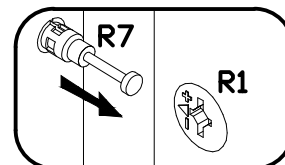
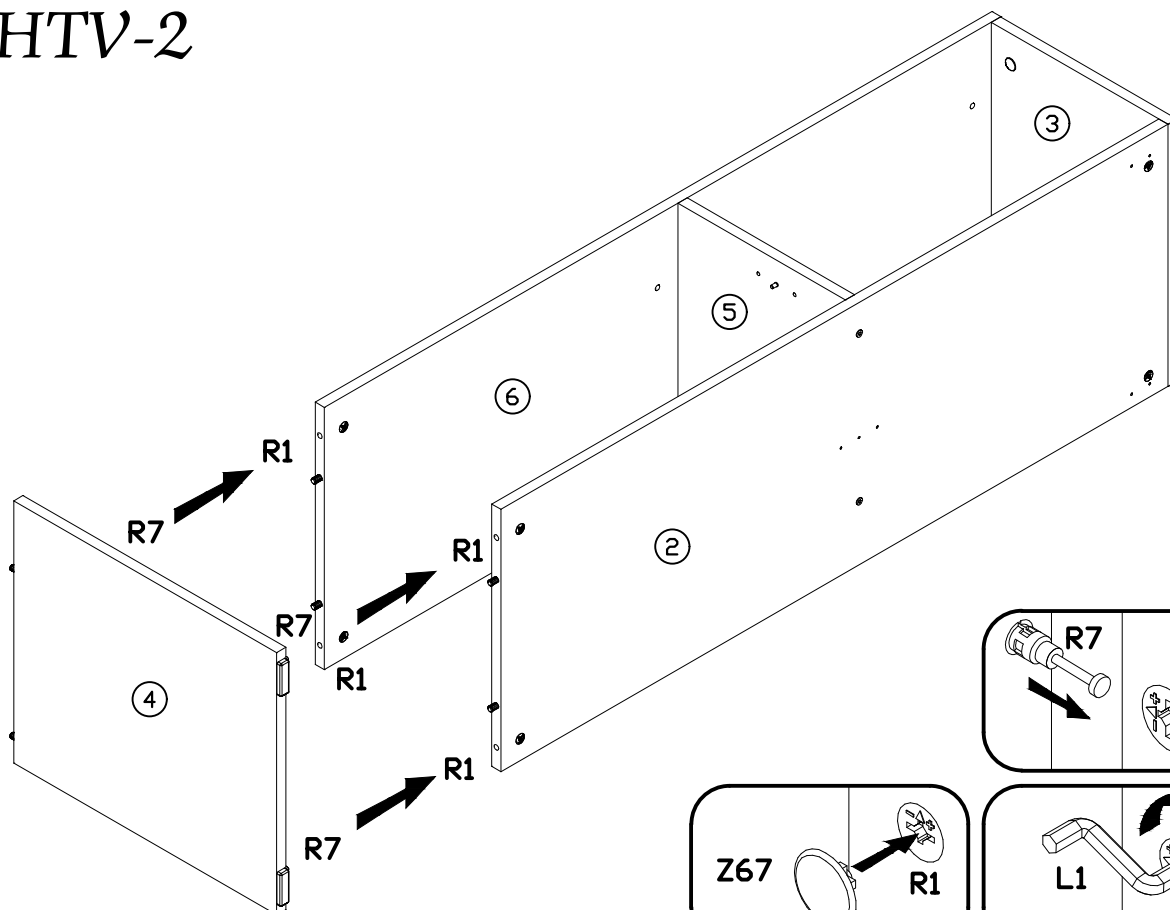

PODCZAS MONTAŻU POSTĘPOWAĆ ZGODNIE Z INSTRUKCJĄ
 WHILE ASSEMBLING FOLLOW THE INSTRUCTION / MONTAGE LAUT DER AUFBAUANLEITUNG DURCHFÜHREN
 PŘI MONTÁŽI POSTUPOVAT PODLE NÁVODU / PRI MONTÁŽI POSTUPOJTE PODĽA NÁVODU

9^{Tfeco} THTV-2

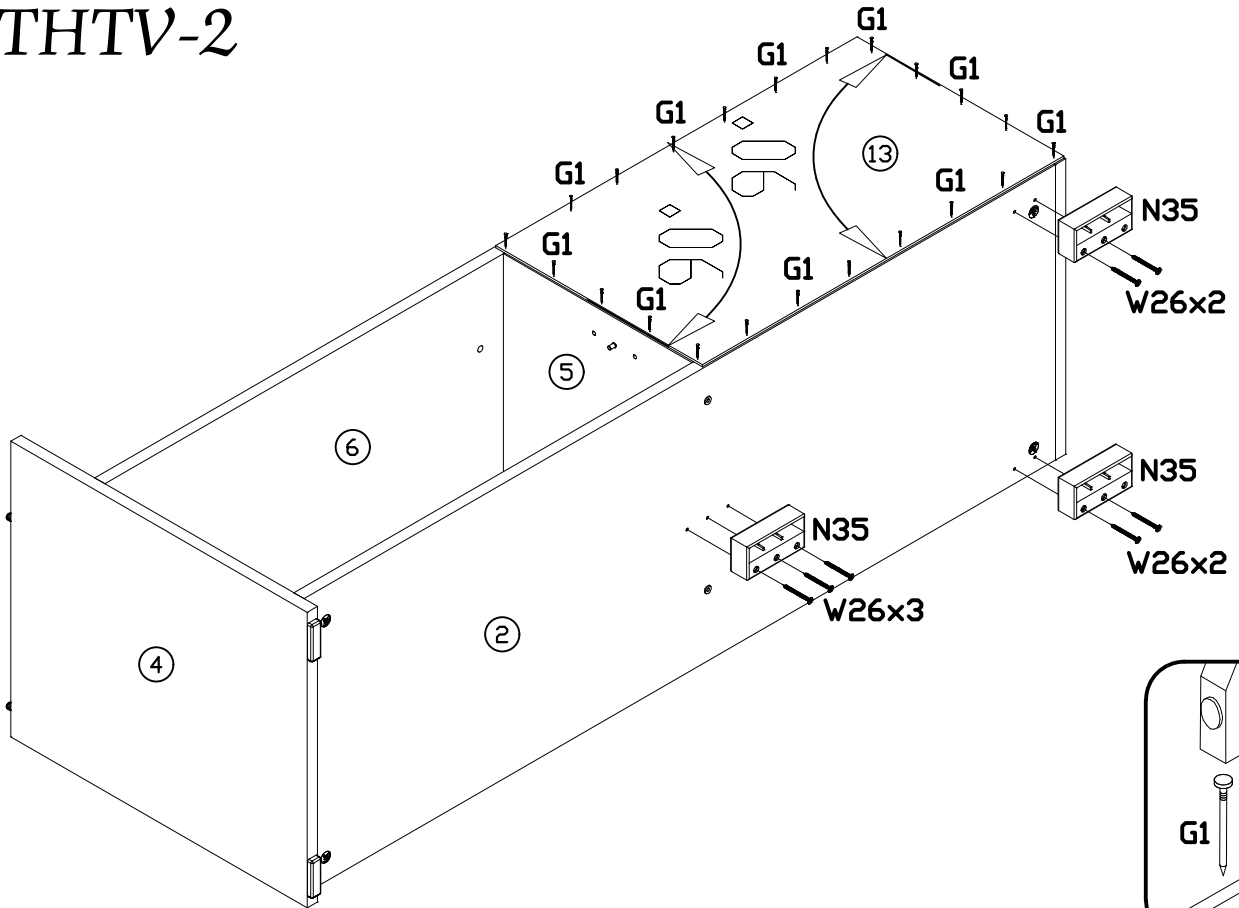

10^{Tfeco} THTV-2

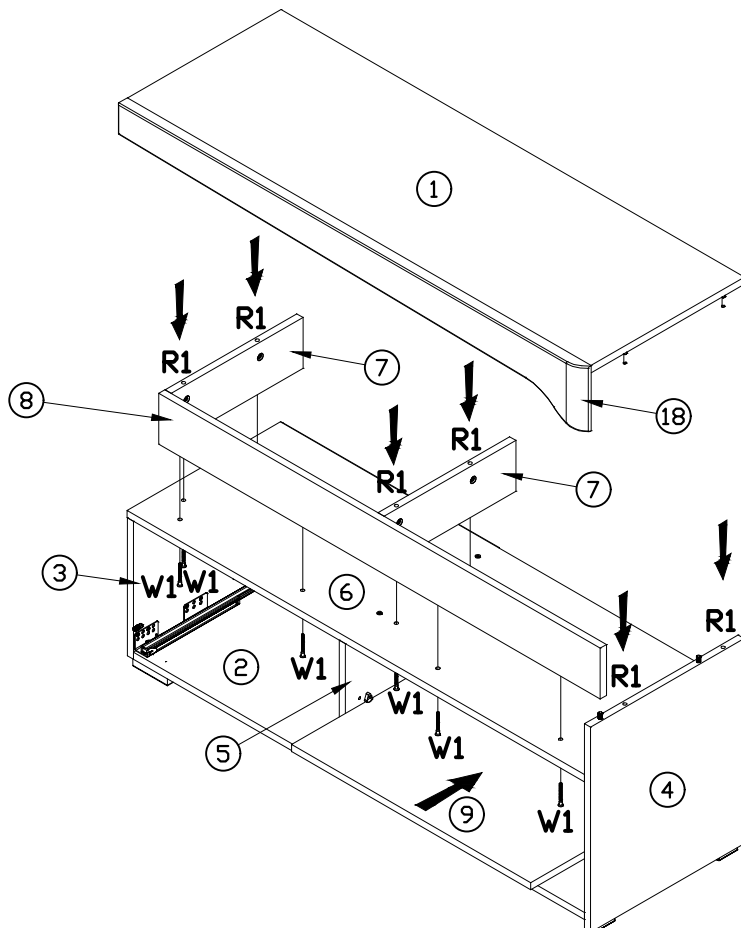
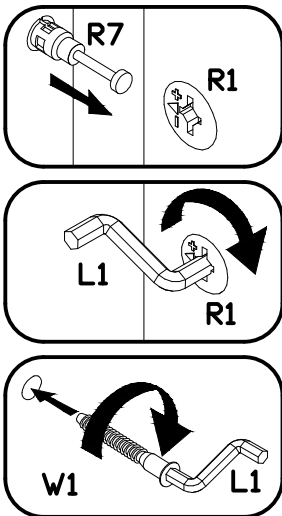

PODCZAS MONTAŻU POSTĘPOWAĆ ZGODNIE Z INSTRUKCJĄ
 WHILE ASSEMBLING FOLLOW THE INSTRUCTION / MONTAGE LAUT DER AUFBAUANLEITUNG DURCHFÜHREN
 PŘI MONTÁŽI POSTUPOVAT PODLE NÁVODU / PRI MONTÁŽI POSTUPOJTE PODĽA NÁVODU

11 Tfco THTV-2

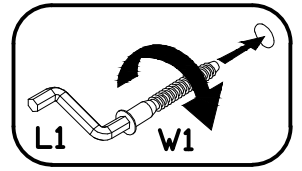
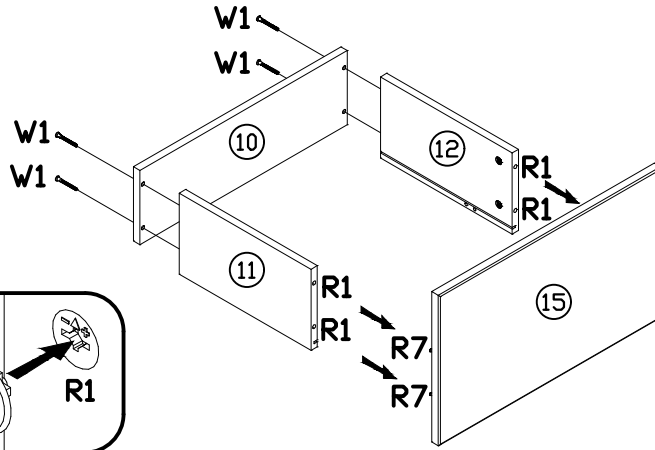
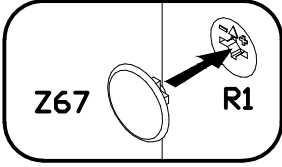
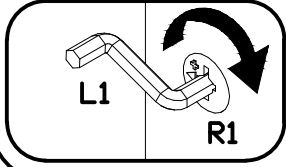
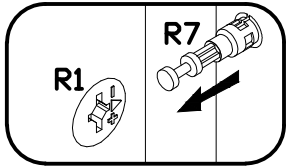

12 Tfco THTV-2

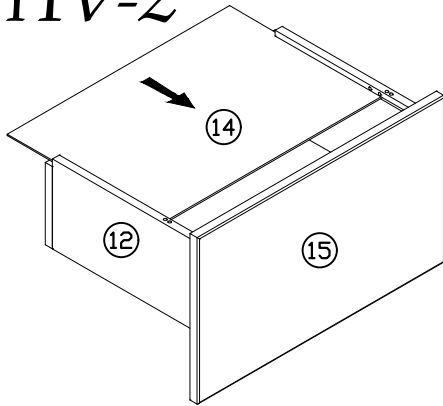

13 Tfco THTV-2

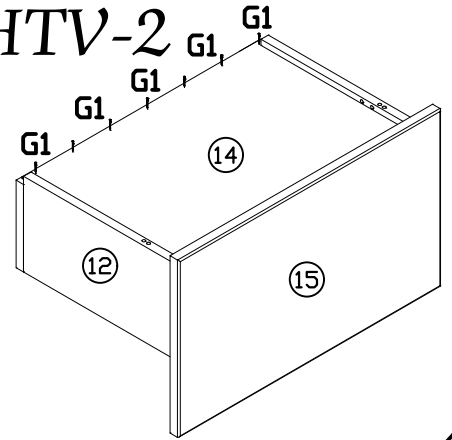
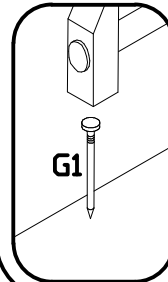

14 Tfco THTV-2

